

**THE INGUL-DONETS  
EARLY BRONZE CIVILIZATION  
AS SPRINGBOARD FOR TRANSMISSION  
OF PONTIC CULTURAL PATTERNS  
TO THE BALTIC DRAINAGE BASIN  
3200 – 1750 BC**

**Jacek Górski**

**Svitlana Ivanova**

**Liubov Klochko**

**Viktor I. Klochko**

**Aleksander Koško**

**Mikola Kryvaltsevich**

**Sergey D. Lysenko**

**Roman O. Lytvynenko**

**Przemysław Makarowicz**

**Vitaliy V. Otroshchenko**

**Gennadiy N. Toshev**

**BALTIC-PONTIC STUDIES**

---

**V O L U M E 18 • 2013**

BALTIC-PONTIC STUDIES

61-809 Poznań (Poland)

Św. Marcin 78

Tel. 618294799, Fax 618294788

E-mail: antokol@amu.edu.pl

EDITOR

Aleksander Koško

EDITOR OF VOLUME

Aleksander Koško

Viktor I. Klochko

EDITORIAL COMMITTEE

Sophia S. Berezanskaya (Kiev), Aleksandra Cofta-Broniewska (Poznań), Mikhail Charniauski (Minsk), Lucyna Domańska (Łódź), Elena G. Kalechyts (Minsk), Viktor I. Klochko (Kiev), Mykola N. Kryvaltsevich (Minsk), Roman Litvinenko (Donieck), Jan Machnik (Kraków), Przemysław Makarowicz (Poznań), Vitaliy V. Otroshchenko (Kiev), Marzena Szmyt (Poznań), Petro Tolochko (Kiev)

SECRETARY

Marzena Szmyt

SECRETARY OF VOLUME

Karolina Harat

Danuta Żurkiewicz

ADAM MICKIEWICZ UNIVERSITY  
INSTITUTE OF EASTERN STUDIES  
INSTITUTE OF PREHISTORY

Poznań 2013

ISBN 83-86094-18-4

ISSN 1231-0344

**THE INGUL-DONETS  
EARLY BRONZE CIVILIZATION  
AS SPRINGBOARD FOR TRANSMISSION  
OF PONTIC CULTURAL PATTERNS  
TO THE BALTIC DRAINAGE BASIN  
3200 – 1750 BC**

**Jacek Górski**

**Svitlana Ivanova**

**Liubov Klochko**

**Viktor I. Klochko**

**Aleksander Koško**

**Mikola Kryvaltsevich**

**Sergey D. Lysenko**

**Roman O. Lytvynenko**

**Przemysław Makarowicz**

**Vitaliy V. Otroshchenko**

**Gennadiy N. Toshev**

**BALTIC-PONTIC STUDIES**

---

**V O L U M E 18 • 2013**

© Copyright by BPS and Authors  
All rights reserved

Cover Design: Eugeniusz Skorwider

Linguistic consultation: Ryszard J. Reisner

Printed in Poland

Computer typeset by PSO Sp. z o.o. w Poznaniu

Printing: Zakłady Poligraficzne TMDRUK in Poznań



THIS VOLUME IS DEDICATED TO THE MEMORY OF

PROFESSOR ALEKSANDRA COFTA-BRONIEWSKA

(13 JANUARY 1926 – 12 MAY 2013)

AND

PROFESSOR MIKHAILO CHARNIAUSKI

(7 MARCH 1938 – 20 JANUARY 2013)

EDITORIAL COMMITTEE, BALTIC-PONTIC STUDIES



# CONTENTS

EDITOR'S FOREWORD . . . . .	7
EDITORIAL COMMENT . . . . .	8
Viktor I. Klochko, Aleksander Koško, THE BALTIC DRAINAGE BASIN IN THE RECONSTRUCTION OF THE MENTAL MAP OF CENTRAL EUROPE HELD IN COMMON BY NORTHERN-PONTIC EARLY-BRONZE CIVILIZATION COMMUNITIES: 3200-1600 BC. AN OUTLINE OF THE RESEARCH PROGRAMME. . . . .	9
PART 1 – CENTRES OF EARLY BRONZE AGE CIVILISATION (COMPOSITE BRONZE METALLURGY) IN THE NORTHERN BLACK SEA DRAINAGE BASIN: TURN OF THE 4TH/3RD MILLENNIUM BC TO CLOSE OF THE 3RD MILLENNIUM BC . . . . .	21
Vitaliy V. Otroshchenko, THE CATACOMB CULTURE PHENOMENON . . . . .	21
Viktor I. Klochko, Liubov Klochko, COMPLEX OF METAL GOODS BETWEEN THE VISTULA AND DNIEPER RIVERS AT THE TURN OF THE 4TH/3RD TO THE 3RD MILLENNIUM BC. CONCEPT OF THE CARPATHIAN – VOLHYNIA “WILLOW LEAF” METALLURGY CENTRE . . . . .	39
PART 2 – THE BALTIC PERSPECTIVE (CENTRAL EUROPEAN) IN THE SYSTEM OF EXOGENOUS CONTACTS OF EARLY BRONZE AGE NORTHERN PONTIC CENTRES: 3RD MILLENNIUM BC TO TURN OF THE 3RD/2ND MILLENNIUM BC . . . . .	72
Gennadiy N. Toshev, IN THE WEST OF THE CATACOMB AREA . . . . .	72
Svitlana Ivanova, CONNECTIONS BETWEEN THE BUDZHAK CULTURE AND CENTRAL EUROPEAN GROUPS OF THE CORDED WARE CULTURE . . . . .	86
Roman O. Lytvynenko, CENTRAL EUROPEAN PARALLELS TO THE DNIEPER – DON CENTRE OF BABYNO CULTURE . . . . .	121
Mikola Kryvaltsevich, BABYNO-TYPE CERAMICS IN THE EASTERN POLESSIYE. .	139
Przemysław Makarowicz, Jacek Górski, Sergey D. Lysenko, PONTIC AND TRANSCARPATHIAN CULTURAL PATTERNS IN THE TRZCINIEC CIRCLE BETWEEN THE PROSNA AND DNIEPER . . . . .	162
References . . . . .	203
List of Authors. . . . .	245





## Editor's Foreword

In 2009, the 14th volume of *Baltic-Pontic Studies (BPS)* ran a series of papers summing up the state of research at that time into the routes between the Baltic and Black seas between the 4th and 1st mill. BC. They are an expression of an early reflection prompted by the need to look more closely at the impact Pontic cultural environments – where composite metallurgy was practised, designated as Early Bronze in this volume – had on the Decline Neolithic and Proto-Bronze settlement centres in the Baltic drainage basin. It is to this question that successive volumes of the *BPS* shall be devoted.

Specifically, according to the research programme aims mentioned above (initial fruits being the papers included in *BPS*, vol. 18) the environments of Northern Pontic cultures – Yamnaya, Catacomb and Babyno – and the Trzciniec cultural circle were identified as generators of the Ingul-Donets Early Bronze Civilization or their immediate neighbours. In proposing this modification of the gamut of phenomena making up the prologue to the European Bronze Age, we intend to suggest the need for a more integrated ('extra-taxonomic') and at the same time, territorially wide-ranging reading of Northern Pontic civilization environments and its cultural interaction in the period from the 3rd to the first half of the 2nd mill. BC.

More arguments in favour of the above opinion can be found in the introductory paper: *The Baltic Drainage Basin in the Reconstruction of the Mental Map of Central Europe Held in Common by Northern-Pontic Early-Bronze Civilization Communities; 3200 – 1600 BC, An outline of research programme.*

## Editorial comment

1. All dates in the B-PS are calibrated [BC; see: Radiocarbon vol. 28, 1986, and the next volumes]. Deviations from this rule will be point out in notes [bc].
2. The names of the archaeological cultures and sites are standarized to the English literature on the subject (e.g. M. Gimbutas, J.P. Mallory). In the case of a new term, the author's original name has been retained.
3. The spelling of names of localities having the rank of administrative centres follows official, state, English language cartographic publications (e.g. *Ukraine, scale 1 : 2 000 000*, Kyiv: Mapa LTD, edition of 1996; *Rèspublika BELARUS', REVIEW-TOPOGRAPHIC MAP*, scale 1:1 000 000, Minsk: *BYELORUSSIAN CARTOGRAPHIC AN GEODETIC ENTERPISE*, edition 1993).

**Roman O. Lytvynenko**

## CENTRAL EUROPEAN PARALLELS TO THE DNIEPER – DON CENTRE OF BABYNO CULTURE

During the Early and Middle Bronze Age, steppe cattle-breeding cultures of the Northern Pontic mainland demonstrated very scarce ties with Europe to the west of the Carpathians. Apparently, these contacts were more visible only in the north-western part of the Northern Pontic Region [Dergachev 1986; 1999; Ivanova 2013; Savva 1992; Toshev 1986], well as those of the forest-steppe Polissya cultures of eastern Europe that displayed certain “corded-ware” and “epi-corded-ware” features, namely the Sub-Carpathian, Gorodok-Zdovbytsa (Mierzanowice), Strzyżów, Middle Dnieper, Balanovo, Fatyanovo, Middle Volga Abashevo and Volsko-Lbishchenskaya cultures [Artemenko 1967; 1987; Bader, Khalikov 1987; Vasiliev 1999; 2003; Yefimenko, Tretyakov 1961; Sveshnikov 1974; Krainov 1972; 1987; Machnik 1958; 1961; Bátorá 2006].

All the more significant, at first glance, are the recently identified parallels between the Dnieper–Don centre of Babyno Culture (DDBC) and central European early Bronze cultures / groups [Klochko, Kravets 1991; Klochko 2006; 2012; Cherniakov 1996; Bratchenko 2001; Lytvynenko 2001; 2006; 2007; 2009; 2011]. The point is that DDBC, together with two other Babyno cultures – the Dnieper-Prut Babyno Culture (DPBC) and the Volga-Don Babyno Culture (VDBC) – and a number of peripheral groups form the Babyno culture circle (area) (Fig. 1) [Lytvynenko 2009a; 2011b; Mymokhod 2013], which in turn, belongs to the post-Catacomb culture bloc of eastern Europe. This fact is very important, as the complex of central European parallels is not demonstrated by the most western of the Babyno cultures (DPBC) but by DDBC, the one that is far more distant from the provisional central European centre of cultural influence.

It is worthy of note that the DDBC archaeological complex clearly displays traces of several constituents: (a) genetic heritage of the preceding Catacomb world (primarily the Donets-Don Catacomb Culture); (b) external innovations; (c) a complex of internal innovations, which are a result of self-development [Lyt-

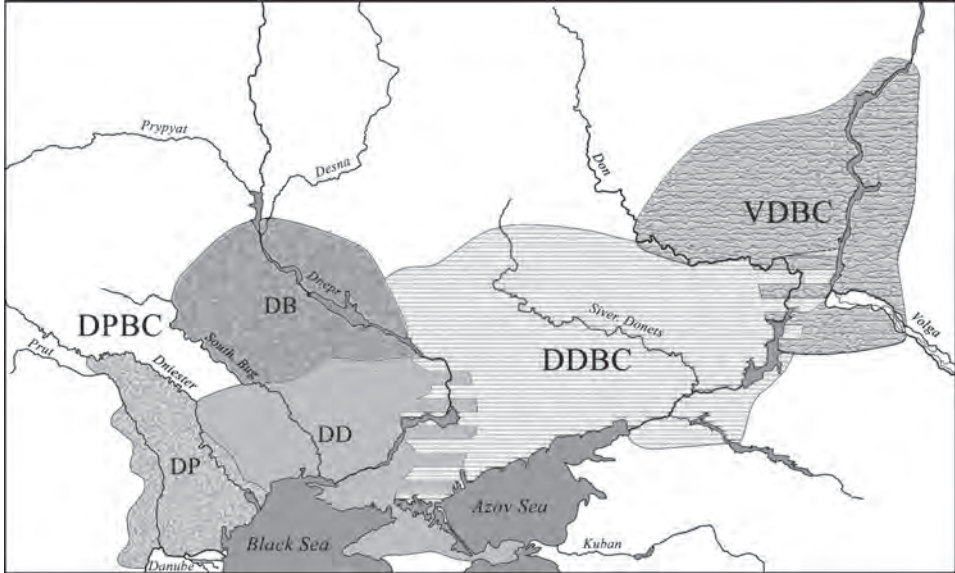

Fig. 1. Babyno cultural Circle: VDBC – Volga-Don Babyno culture; DDBC – Dnieper Don Babyno culture; DPBC – Dnieper-Prut Babyno culture (local variants: DB – Dnieper Bug; DD – Dnieper-Dniester; DP – Dniester-Prut)

vynenko 2011a]. This article will focus therefore on the second constituent of the Babyno culture complex, namely, the complex of external innovations. The external innovations include a part of the DDBC culture complex that cannot be linked to the local genetic source (i.e., the Catacomb cultures) and, at the same time have convincing similarities outside. Such external innovations include a peculiar set of decorations and garment details: bronze neck torcs, oculus-like – binocular pendants, spiral (spring) bracelets; necklaces of tin rolled tubules and spiral cylinders, drilled predators' fangs; bone / horn hook-cleat and ring buckles; stone bars with drilled holes at the edges (commonly interpreted as archers' protective plates). Another external innovation is the binary opposition principle in the burial rite (based on gender): fully opposite orientations and poses for men and women, with the relevant difference in the composition of burial implements. That sub-complex of the material culture and the burial rite (Fig. 2), although not typical for the steppe cattle-breeding cultures of the Pontic – Caspian Region and impossible to derive from the local source, has rather close similarities in the Epi-Corded Ware horizon of the Carpathian – Danube Region's cultures / groups, which chronologically mostly belong to Phases A1-A2 (after Reinecke) of the early Bronze Age.

First and foremost, the focus is on the analogies found in the environment of the pre-Carpathian Epi-Corded-Ware cultural circle, identified by Machnik [1972], which practiced the production of wire decorations (made with the use of the wil-

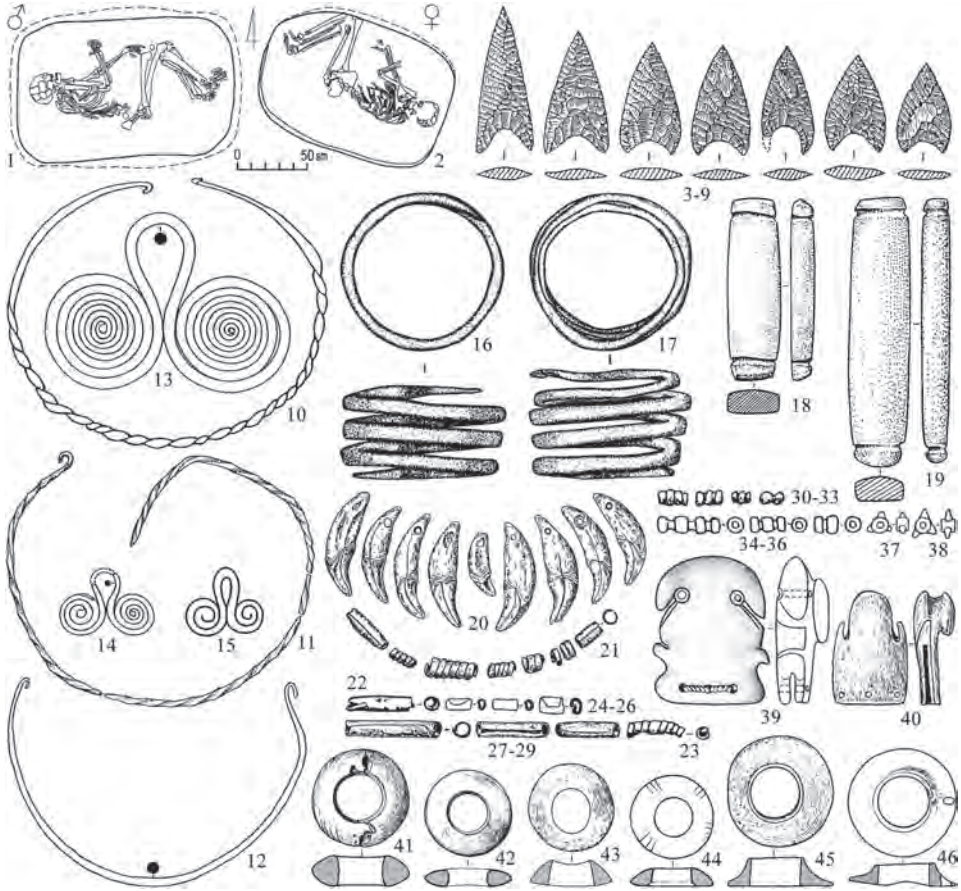

Fig. 2. Central European parallels in the burial rite and the material complex of DDBC: 1 – Rebrykovka-II 1/3 (no. of barrow / grave) 2 – Rebrykovka-II 1/5; 3-9 – Beyeva Mohyla grave 3; 10 – Hnarovske 1/6; 11 – Kerchyk, Gat-III 16/5; 12 – Vidrodzhennyya-II2/4; 13 – Shakhtarsk 8/2; 14 – Chykmari-II 1/4; 15, 27-29 – Novo-Pylypivka 2/4; 16-17 – Oleksandrivsky hoard; 18 – Novozaryivka 2/2; 19 – Pryvillya 11/13; 20 – Obilne 2/5; 21 – Kerchyk 17/9; 22-23 – Vetyutniv 2/1; 24-26, 37 – Novooleksandrivka-I 2/1; 30-33 – Andriyivka 1/1; 34-36 – Sokolove 5/11; 38 – Buzivka-XXII 1/6; 39 – Donetsk 4/19; 40 – Novolakedemonivka grave 10; 41 – Mykolayivka 1/8; 42 – Pryvillya 1/5; 43 – Petrovske 1/4; 44 – Spaske-IX 1/5; 45 – Pryvillya 7/4; 46 – Tsymlyansk 2/3

low-leaf technique) [Kadrow 2000], namely the Mierzanowice and Nitra cultures. Specifically, burial rites of all cultures of the pre-Carpathian cultural circle, like DDBC, involved the principle of opposition in the poses and orientations of the dead of different sexes, though in a version that was opposite to the one practiced in Babyno burials [Lutteropp 2009; Machnik 1972: 58-65, 88-92, 146, 152-154, 163-165; Müller-Karpe 1974, Fig. III/1: 248, 250; Stloukal 1985: 167]. Coinci-











Artifacts/ritual Cultures											
Babyno (DDBC)											
Mierzanowicka											
Strzyżowska											
Nitra											
Únětice											
Unterwöblinger											
Straubinger											
Singen											
Adlerberg											
Rhone/Wallis											
Ries											
Neckar											
Kisapostag											
Vatya											
Mures-Periam											

Fig. 3. Common elements of material culture and funeral ritual in cultures / groups of Central Europe and DDBC  
\* gender opposition in the burial rite



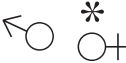
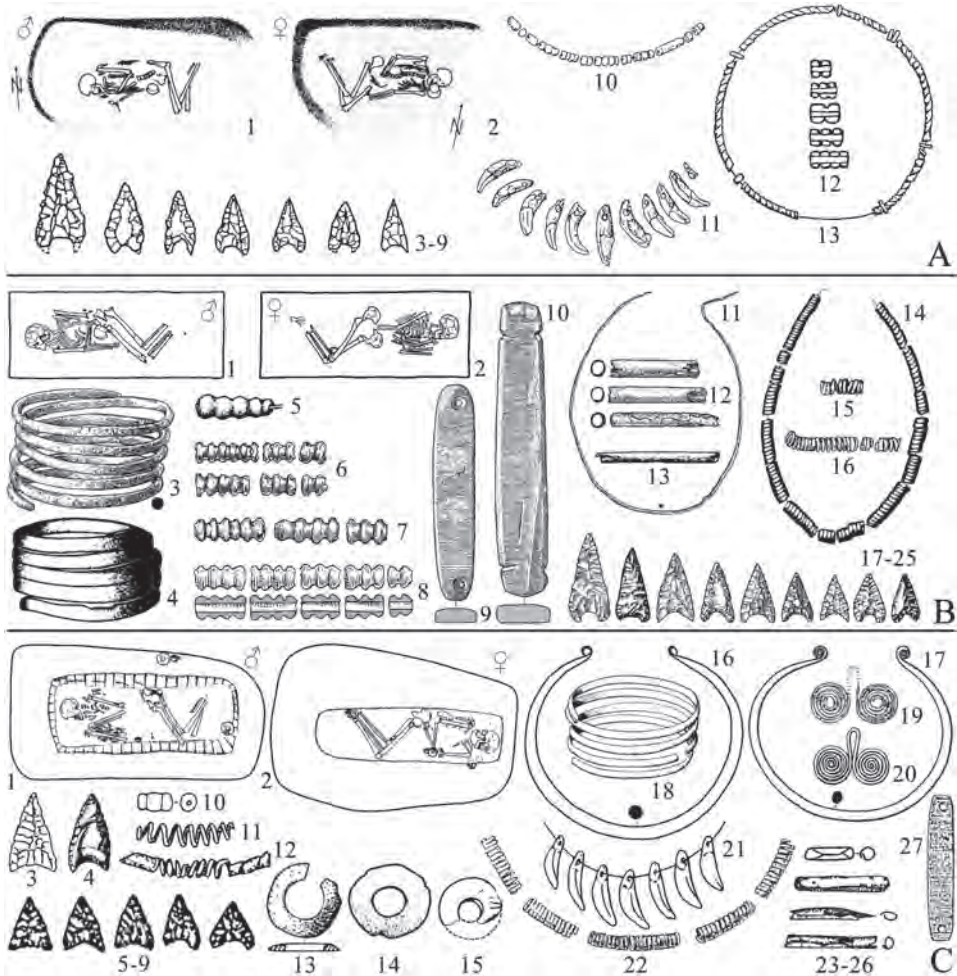

Fig. 4. Central European analogies of the funeral ritual and material complex of DDBC: A – Mierzanowice culture; B – Nitra culture; C – Únětice culture

dences at the level of material culture refer mainly, though not exclusively, to the set of decorations. The categories of items, common with DDBC, include (Fig. 3):

*Mierzanowice culture* (Fig. 4: A) – necklaces of copper-bronze spiral rolled tubes (German Spiralröllchen aus Bronze/Kupferdraht), tin shells (Bronzeblechhülle), faience beads and segmented cylinders (Segmentierte zylindrische Perle aus glasartiger Masse), drilled canine fangs – *Canidae* (Durchlochte Wolfszähne) flint dart heads with a groove at the base (Flächenretuschierte Silexspitze mit kontraver Basis) [Kadrow, Machnik 1997: Fig. 23, 3, 5, 20-28; 32; 34; 68]

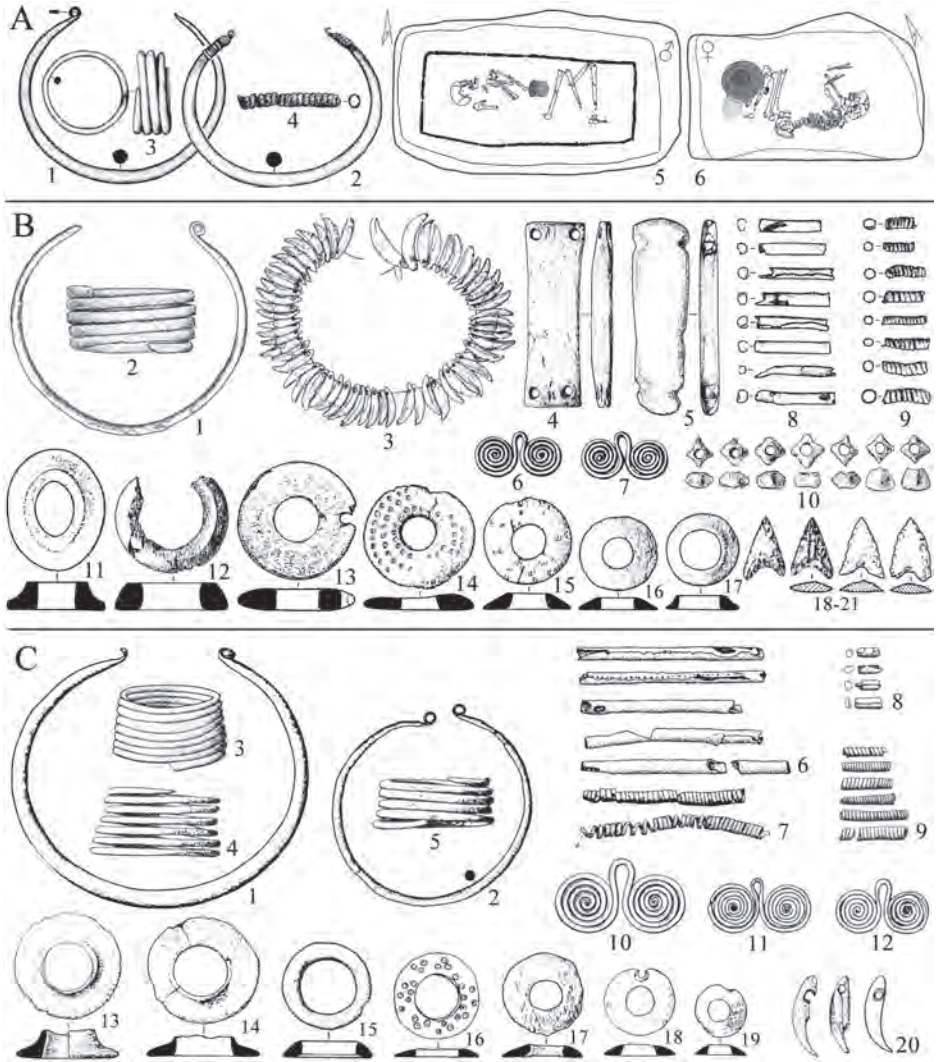

Fig. 5. Central European analogies of the funeral ritual and material complex of DDBC: A – Gata-Wieselburg cultural group; B – Unterwölbling cultural group; C – Straubing cultural group

*Nitra culture / group* (Fig. 4: B) – copper–bronze neck torcs with loops (Ösenhalsring) spiral protective bracelets (Armspirale) stone plates with transverse grooves (a rarer kind of archers’ protective plates, compared to drilled ones – English: Bracer, German: Armschutzplatten, Polish: płytką łuczniczą, Slovak: nátepní ploténka) [Sangmeister 1974; Fokkens, Achterkamp, Kuijpers 2008] necklaces of bronze spiral cylinders, tin rolled beads, faience beads and segmented cylinders; arrow-heads with a grooved base [Müller-Karpe 1974; Ondráček 1985].



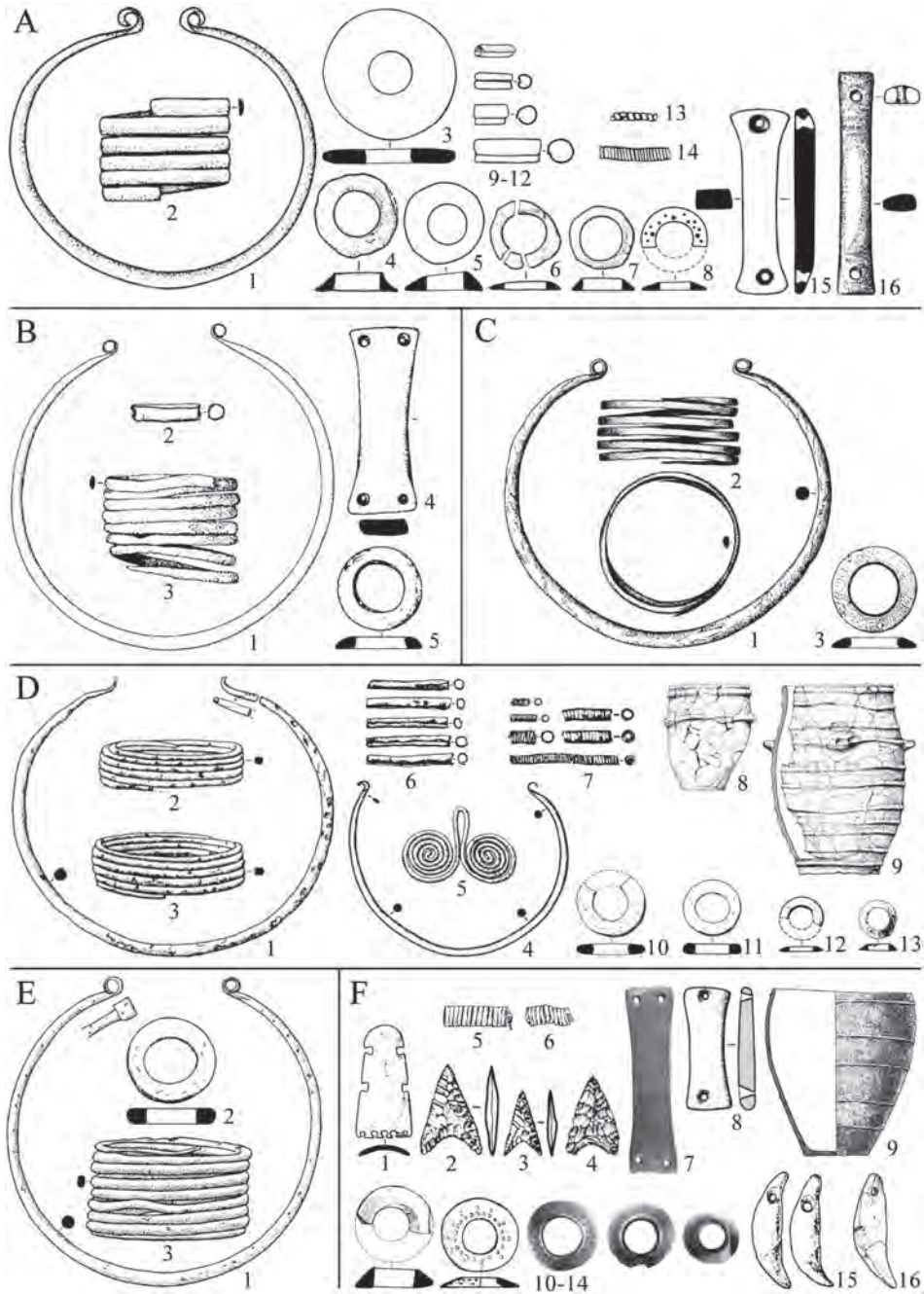

Fig. 6. Central European analogies of funeral ritual and material complex of DDBC: A – Adlerberg cultural group; B – Ries cultural group; C – Neckar cultural group; D – Rhone / Wallis culture / group; E – Singen cultural group; F – Polada culture

Further west and north-west, in the basins of the Vistula and Oder, the Upper Danube, the Upper and Middle Rein, as well as the neighbouring areas of the Alps (Bohemia, Moravia, southern Bayer, Middle Germany, Gessen, Lower Austria, Switzerland and Northern Italy) there are a number of more or less similar culture groups of the early Bronze Age, which chronologically occupy the common European epi-corded-ware horizon (periods A1 – A2, after Reinecke): *Únětice* (*Únětice Kultur*), *Gáta-Wieselburg*, *Unterwölbling* (*Unterwölbling Gruppe*), *Straubinger* (*Straubinger Gruppe*), *Singen* (*Singen Gruppe*), *Adlerberg* (*Adlerberg Gruppe*), *Ries* (*Ries Gruppe*), *Neckar* (*Neckar Gruppe*), *Rhone/ Wallis* (*Rhone/ Wallis Kultur/Gruppe*) and *Polada*. A complex of common features also makes these groups culturally similar to DDBC. Almost all demonstrate the principle of gender-based orientation in the burial rites of men and women, though somewhat different from the Babyno version [Bartelheim 1998, Tab. 1: 176; Müller-Karpe 1974, Fig. III/1: 256, 257, 260; Nagy 2013: 90]. The list of similarities between the Babyno material complex (DDBC) and those groups / cultures is rather remarkable (Fig. 3):

*Únětice culture* (Fig. 4: C) – copper – bronze neck torcs, spiral protective bracelets, binocular pendants; necklaces made of metal spiral cylinders, tin rolled beads, faience beads and segmented cylinders, drilled canine fangs; bone rings (*Knochenscheibe*) flint arrow-heads with a grooved base; archer's protective plates [Bartelheim 1998, Tab. 1: 56-57, 63, 74-79; TAB. 2: Plate 45, R1; 46, S6.1; 47, U1, 5, 7, 10; V1; Matuschik 1996: 23; Müller-Karpe 1974, Fig. III/1: 250, 252-255; Fig. III/3: Plate 525, A; Fig. III/4: Plate 300, A, G]

*Gáta-Wieselburg culture* (Fig. 5: A) – copper-bronze neck torcs, spiral protective bracelets, binocular pendants; necklaces of metal spiral cylinders, drilled fangs [Honti, Kiss 2013: 750; Müller-Karpe 1974, Fig. III/1: 248; Nagy 2013: 90-92, 101-102, 103-104, Plate 1; 14; 24, 1-2; 29, 3-4; 30, 6]

*Unterwölbling group* (Fig. 5: B) – copper-bronze neck torcs, spiral protective bracelets, binocular pendants; necklaces of metal spiral cylinders, drilled canine fangs, tin rolled beads, faience beads (in particular, with four protruding parts) bone rings; archers' stone protective plates and fling arrows with a grooved base [Bertemes 1989: Plate 27, 1-2, 8-13, 24-25, 28; Koschik 1981: 112-115; Plate 49, 5; 60; 61, 7; Lißner 2004: 5, Tab. 3-6; Matuschik 1996: 23; Müller-Karpe 1974, Fig. III/3: Plate 528-529; Neugebauer C., Neugebauer J.-W. 1997: Tab. 1; Ruckdeschel 1978: 194]

*Straubinger group* (Fig. 5: C) – copper-bronze neck torcs, spiral protective bracelets, binocular pendants; necklaces of metal spiral cylinders, drilled canine fangs, tin rolled beads, bone rings of several types; archers' plates [Hundt 1958; Lißner 2004: 3, TAB. 2-6, Plate 2-3; Matuschik 1996: 23; Müller-Karpe 1974, Fig. III/3: Plate 530-533; Ruckdeschel 1978: 192-196, Fig. 17:1-7, 20]

*Adlerberg group* (Fig. 6: A) – copper-bronze neck torcs, necklaces of tin rolled beads, spiral cylinders and drilled fangs, bone rigs, archers' plates [Gebers 1978;

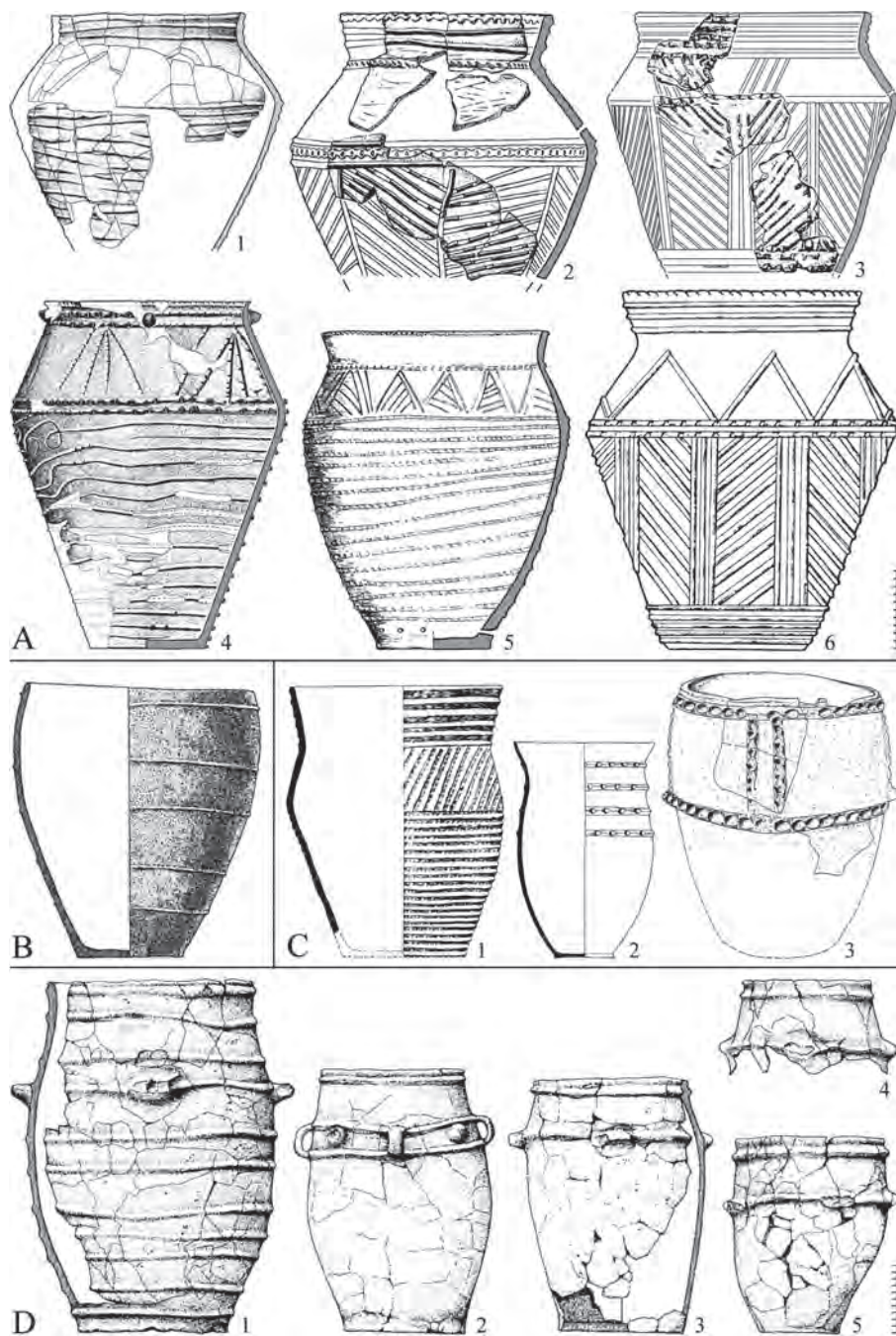

Fig. 7. Ceramics with Mnogovalikovaya (multi-cordoned) décor: A – DDBC; B – Polada culture; C – Adlerberg group; D – Rhone/Wallis culture



Lißner 2004: 2-3, TAB. 2-6, Plate 1; Müller-Karpe 1974, Fig. III/3: Plate 534; Ruckdeschel 1978: 194-195]

*Ries group* (Fig. 6: B) – copper-bronze neck torcs, spiral protective bracelets, tin rolled beads, bone rings, archers' plates [Lißner 2004: 3-4, TAB. 2-6, Plate 5]

*Neckar group* (Fig. 6: C) – copper-bronze neck torcs, spiral protective bracelets, bone rings [Lißner 2004: 4, TAB. 2-6, Plate 6]

*Rhone culture (Wallis group)* – copper-bronze neck torcs; spiral cylinders, hooked buckles; tin rolled beads; bone rings (Fig. 6: D) [Hafner, Suter 2003: 327, 328-329, Fig. 2-5; Müller-Karpe 1974, Fig. III/1: 262; Ruckdeschel 1978: 194]

*Singen group* (Fig. 6: E) – copper-bronze neck torcs, spiral protective bracelets, binocular pendants; spiral cylinders, tin rolled beads, bone rings [Lißner 2004: 3, Tab. 2-6, Plate 4]

*Polada culture* (Fig. 6: F) – bronze binocular pendants, necklaces of spiral cylinders and drilled fangs, bone rings and hooked buckles, flint grooved arrow-heads and archers' protective plates [Barich 1971: Fig. 13, 3, 6, 7, 11, 13, 17, 18; 14, 16; 15, 11-12; 19, 3-5; Bartelheim 1998, Tab. 1: 79; Fasani 1984: 498, Fig. 16; 501, Fig. 1-2; 502, Fig. 9:12; 516, Fig. 2.12; 1988: Fig. 5:11-35; 6, 17-18, 21; Grigoriev 2002: 390; Marzatico, Tecchiati 2001: Fig. 1:22, 23, 29; Matuschik 1996: 20, Fig. 11; Perini 1971: 65, Fig. 32, 2.12; 33, 1; Ruckdeschel 1978: 194].

It is worthy of note that, some of the above groups of that time (Adlerberg, Wallis / Rhone, Polada, Straubing *et al.*) developed a fashion for decorating ceramics with smooth and carved rolls, sometimes whole compositions thereof (Fig. 7) [Gebbers 1978: Plate 19, 20; 57, 20-29; 59, 17-19, 24, 63, 14; 64, 17-20, 24-26; 66, 4-5, 9-11; Grigoriev 2002: 390, Fig. 148, 15, 29; Hafner, Suter 2003: Fig. 11, D; Hundt 1958: Plate 20-47]. This circumstance is an additional proof in support of certain epoch-wide parallelism in the genesis of DDBC and Early Bronze Age central European cultural groups.

Also worthy of note is the fact that DDBC is not the only culture that finds clear parallels among the early Bronze Upper Danube cultures and groups, but also among the Middle and Lower Danuber cultures. As an example, one can refer to the Middle Bronze Age cultures / groups of Hungary and Serbia, as well as the early Bronze Age of Romania:

*Kisapostag group* (Fig. 8: A) – copper-bronze spiral bracelets, binocular pendants, necklaces of metal tin rolled beads, spiral cylinders and dripped fangs [Machnik 1978: 23; Müller-Karpe 1974, Fig. III/1: 247; Fig. III/3: Plate 521; Melis 2013: 3-4, Fig. 5; 8; Szathmári 1983]

*Vatya culture* (periods I, II) (Fig. 8: B) – copper-bronze spiral bracelets, binocular pendants, tin rolled beads and spiral cylinders faience necklace with protrusions, archers' stone plates [Bona 1975: 51, Plate 16, 19, 21, 26; Müller-Karpe 1974, Fig. III/1: S. 247-248, Plate 527; Szathmári 1996; 76, 78-80, Fig. 3:4-8, 18-21; 5, 5-10, 38-43, 52-63; 6, 1, 3; 2002: Fig. 2:12-13; 4, 2-5].

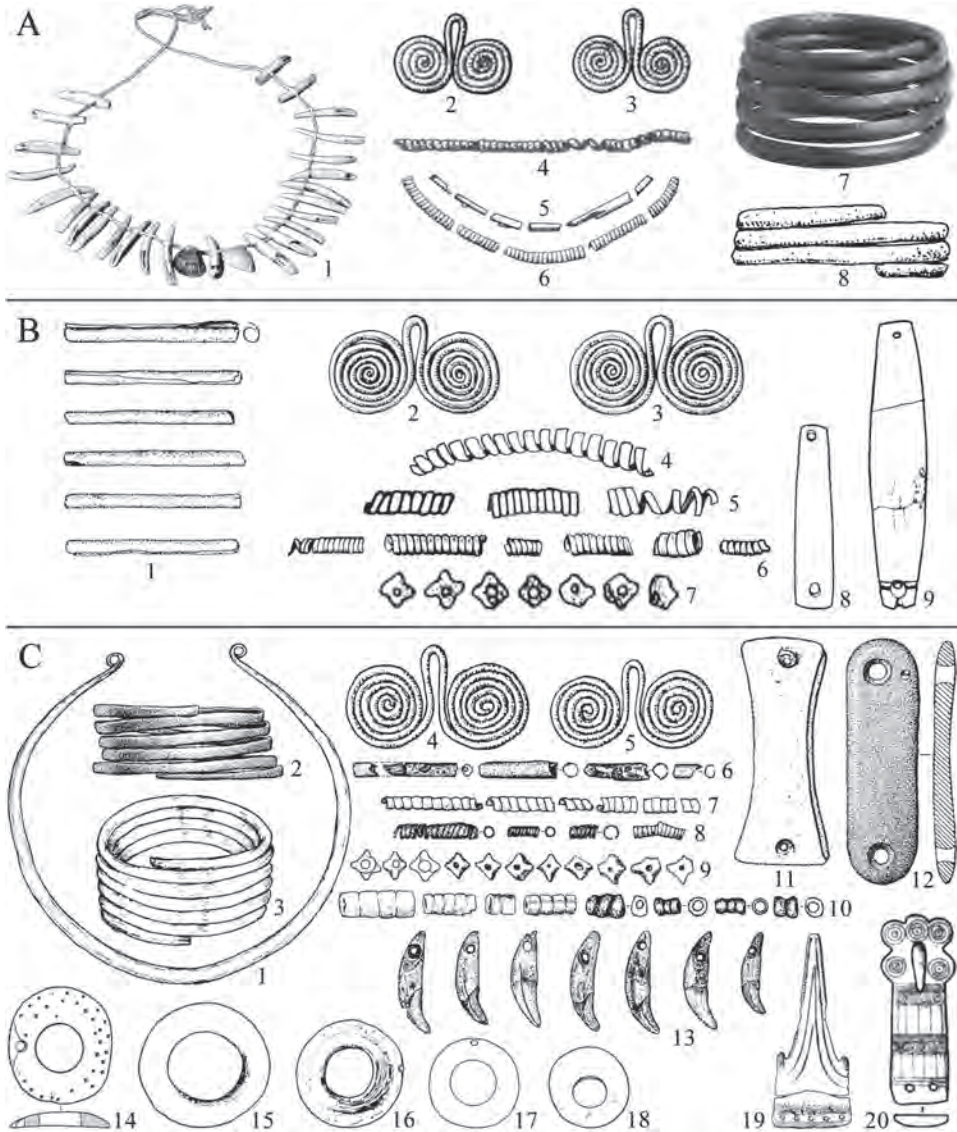

Fig. 8. Central-eastern European (Middle Danube) analogies of funeral ritual and material complex of DDBC: A – Kisapostag cultural group; B – Vatya culture; C – Mures / Periam (Szőreg) culture

*Mures (Maros, Maris) culture or Szőreg group of Periam (Perjámos) culture* – gender opposition in male and female inhumations, copper-bronze neck torcs, spiral bracelets, binocular pendants, tin rolled beads and spiral cylinders, faience



Fig. 9. Cultures / groups of the Central, South-Eastern and Southern Europe bearing common features of the material culture and the funeral rite: 1 – Rhone / Wallis; 2 – Singen; 3 – Adlerberg; 4 – Neckar; 5 – Ries; 6 – Straubing; 7 – Unterwölblinger; 8 – Únětice; 9 – Nitra; 10 – Mierzanowice; 11 – Strzyżów; 12 – Kisapostag; 13 – Vatyá; 14 – Mures / Periam (Szóreg) 15 – Babyno (DDBC)

necklace of faience segmented cylinders and beads with four protrusions, as well as drilled canine fangs, bone rings, archers' plates (Fig. 8: C) [Bratchenko 2001: 47; Bende, Lörinczi 2002: Fig. 6:5; 8, 5; Bona 1975: 85-86, 102, Plate 85, 87, 116, 120, 122, 123; Girić 1971; Matuschik 1996: 23; Müller-Karpe 1974, Fig. III/1: 251; Fig. III/3: Plate 520, F; Ostojuhevo 1994: catalogue, No. 24; Stefanović 2006: 201-212; Szabó Gábor 1997: Fig. 7; 8; 9, 12-19; 10, 34-38, 45-48; 11].

*Monteoru culture* (phases IC<sub>3</sub>-Ia) – bronze neck torcs, necklaces of tin rolled beads and spiral cylinders, drilled fangs, an axe and an adze of the Kostroma type, bone rings, flint arrow-heads with a grooved base (Fig. 9) [Savva 1992: 159-169, Fig. 63; Motzoi-Chicideanu 1995: 235, Fig. 11, 5, 8].

Obviously, the very complicated task of clarifying the chronological correlation of DDBC periodisation stages and relevant phases of the above cultures and groups is a matter of further research, as those cultures and groups are not absolutely synchronous but, most probably, demonstrate partial co-existence.

Of particular note is that the identified parallels in the material complexes of the compared cultural areas of, on the one hand, central and south-eastern Europe,

and, on the other hand, of eastern Europe, are numerous and repetitive in their occurrence enough to suggest a general common conditionality and not an accident of this phenomenon. Naturally, when making such ambitious conclusions one should provide substantial proof that some kinds of decorations, particularly the neck torcs, wristband-like spiral bracelets, oculus-like pendants, tin rolled beads, spiral cylinders and alike, are used correctly in chronological assumptions. There is an opinion that such categories of objects may not be used for constructing sophisticated chronological schemes, as they, allegedly, demonstrate a vast time range of practical usage that spans throughout the Eneolith – Bronze period. At a glance, one can accept this reasoning, as for the majority of the above artefacts it takes little effort to demonstrate their practically uninterrupted chronological sequence from the Copper Age till the end of the Bronze Age. However, the point is that in order to construct such a sequence one would have to artificially collect the material from various sites of Europe, the Caucasus and even Western Asia. Moreover, it will become evident that none of the local regions of Western Eurasia (the Balkans, the Carpathian basin, the Danube Region, the Northern Pontic Region, the Don-Volga-Urals Region, the Caucasus, Anatolia, the Middle east, etc.), which sometimes demonstrated uninterrupted cultural heritage throughout the entire Paleo-Metal Age, will be able to demonstrate permanent usage of the above elements of decorative sets.

For instance, even such relatively simple to make and unpretentious-looking jewellery as tin and spiral cylinders are also not permanently present chronologically at a certain territory throughout a number of periods. In the Northern Pontic Region and the adjacent steppe areas, such cylinders were commonly present only in the Late Steppe Eneolith and Late Yamnaya monuments [Bratchenko 2001: Plate I: 42]. Such decorations are already not typical for the early Catacomb and Middle Catacomb monuments [Bratchenko 2001: Plate I: 43-45; Plate II: Fig. 74; 104, B, C]. A new state of usage of the above types of jewellery can be traced only from the Late catacomb period and not everywhere, as they are found only in some areas [Dergachev 1996: 106; Syniuk 1996: 118, 131-132, Fig. 35, 5; 41, 57; Toshev 1991: 96, Fig. 5:3-4; Feschenko 1992: 95, Fig. 2:4]. On most of the territory of left-bank Ukraine, tin and spiral cylinders are absolutely absent in the Catacomb culture jewellery sets; they only occur in that territory at the end of the Middle Bronze Age, more specifically, with the early stage of DDBC monuments. After a rather short period of usage, they disappear again and never re-occur in the late-stage Babyno complexes and the subsequent Srubnaya cultures. Somewhat similar (though with its own peculiar features) cycles of usage of the above jewellery can be observed in the regions further to the west and to the east of the Babyno cultural area. These facts need to be taken into account and demand a more balanced, sophisticated attitude to the evaluation of chronological potential of even relatively simple and undemonstrative categories of items that are routinely classed among the so-called background types.



Second, there is another, more significant argument that supports the correctness and relevance of our assumption of the typological – chronological parallels between DDBC and archaeological entities of Central Europe. It is the fact that the central European cultural groups, included in the comparison, demonstrate the whole series of clear and sustainable similarities (up to 7-10 points), not only individual analogues, often together with characteristic features of the burial rites (gender-based binary opposition, burial constructions represented by wooded frames).

As mentioned above, given a systemic and complex approach, these common elements of the ritual and material culture can no longer be seen as the “background”, but as diagnostic features, a certain “fashion” of the epoch that proliferated in the early Bronze Age throughout the significant territories of Europe, not only its western part alone, but also, partially, to the eastern part. For never before or after this chronological period that corresponds with phases A1b – A2a (after Reinecke), central European cultural groups demonstrated so many common features [compare: Lißner 2004: 5-6]. Moreover, never again in other periods of the Bronze Age the eastern European cultures demonstrated so clear parallels with the central and eastern European, as can be observed in the case of the Babyno culture circle, primarily the DDBC. Hence, these are not individual accidental coincidences, but a sustainable systemic parallelism in the development of the compared central and eastern European cultural entities, which was possible only if they co-existed within the same epoch.

Third, the above chronological comparisons may not be devaluated by the fact that a certain proportion of western parallels, identified in the DDBC material complex, are not represented in large numbers, but only by individual finds in graves: metal torcs (4 finds), oculus-like pendants (3 finds), tin rolled beads (8 finds), spiral cylinders (3 finds), spiral bracelets (a hoard, 1 find) and archers’ stone plates (6 finds). In this case, the small numbers do not reduce the quality and the essence of the phenomenon. Of particular significance is the fact that a similar situation can be observed among the central European close / related groups of the early Bronze Age, synchronous to the Babyno, in which the same categories of the material culture are represented in different numbers and with different frequency. Meanwhile, the frequency of the occurrence of specific categories of artefacts is not directly connected to their status as determining (diagnostic) markers [Lißner 2004: 5, 6]. In this case, importance lies in the fact that all of the above items (with the exception of bronze cylinders) are absolutely unknown in the material complexes of Eneolithic, Yamnaya and Catacomb monuments of the Northern Pontic Region; therefore, they could not be inherited by bearers of the Babyno culture from the preceding local cultural environment.

In order to prove this author’s conclusions about the involvement of the Central European (Carpathian – Danube) impulse in the formation of DDBC is correct, one needs to refer to the absolute chronology data. A series of  $^{14}\text{C}$  dates identifies the time of the existence of the Babyno Culture Circle within the range of 2200-1700 BC



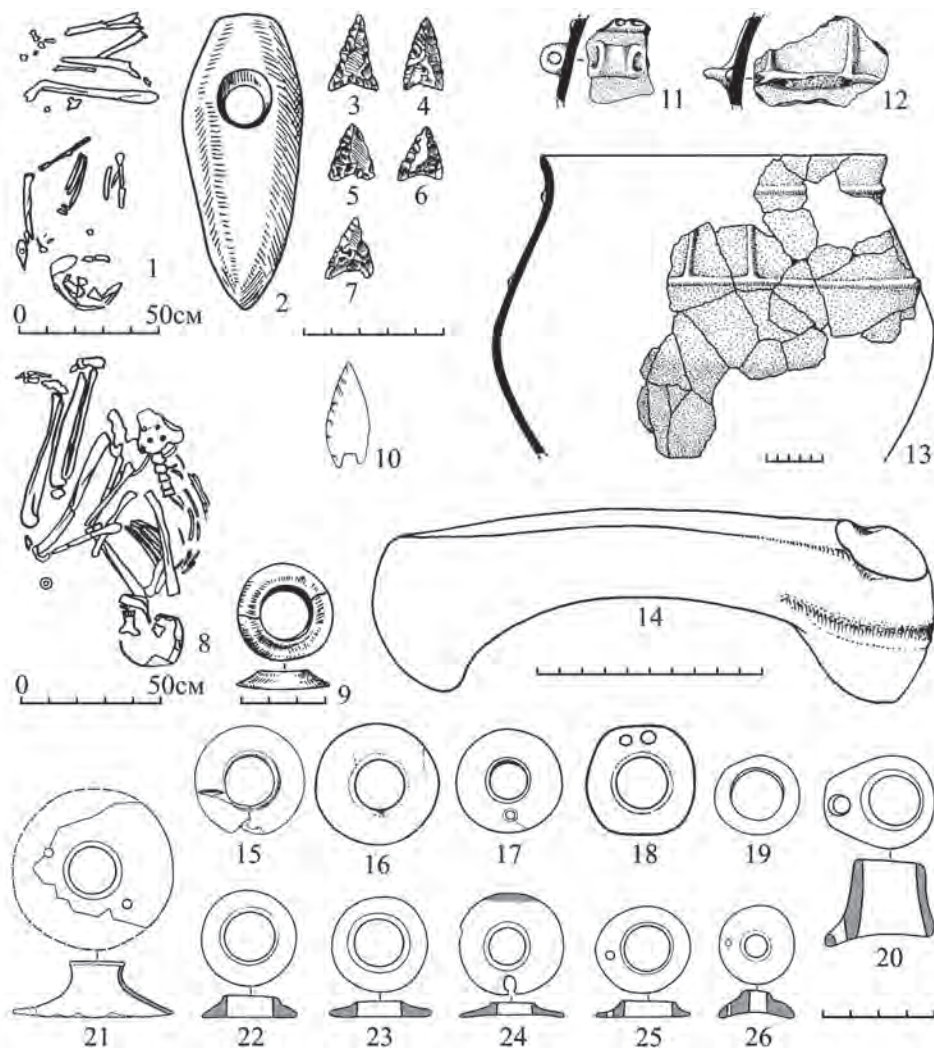

Fig. 10. Romanian analogies of burial inventory of DDBC: 1-7, 8-9 – Girceni 2/4; 11-13 – Măgura Dudașului; 10, 18 – Baldovinești, burial 3, 12; 14 – Mircin; 15-17 – Brailița, burial 158, 86, 145; 20, 24 – Sărata-Monteoru; 21-23, 25-26 – Kindești

cal. [Lytvynenko 2009a: 14-15; Mymokhod 2010: 34-43; 2011: 38-45]. Hence, the Babyno Culture Circle is synchronous with certain phases of the above central European early Bronze Age cultures / groups, which existed within the periods A1-A2 of Reinecke's scheme. It should be noted that the early DDBC horizon – which is the one marked with Carpathian – Danube features – dates back to the range of about 2200-2000 BC cal. and should correspond with the central European period A1a of



Fig. 11. A. Epi-Corded-Ware entities of Western Podolia and Carpathians: 1, 8 – Kutianka (Iserna); 2 – Horodenka; 3 – Lypa; 4 – Velykyi Boratyn; 4a – Torchyn; 5 – Stadnyky; 6 – Pochapy; 7 – Ozlyiv; 9 – Rusyliv; 12, 16 – Surmychi-III; 13 – Tarakaniv; 14 – Lahodiv; 15 – Zoziv-II; 17 – Svytaziv; 18 – Zvenyhorod; 19-22 – Palykorovy; 23,24 – Pereverdov; B. Strzyżowska culture.

Reinecke's modified scheme, or the end of the early Hellas period (EH-III). The late phases of Babyno are generally synchronous with the eastern European period A2b, or the beginning of the Middle Hellas period (MH-I). It is particularly important that the central European (Carpathian – Danube) sub-complex can be observed only at the early stage of DDBC (period I). That sub-complex serves as a certain marker, which, taken together with other indicators, reliably proves the end of the Catacomb culture age and the beginning of a new, post-Catacomb one. At the beginning of period II (phase II-A), the central European sub-complex disappears completely and, subsequently, practically never re-appears in DDBC's material culture and the burial rite. This circumstance can be explained by the fact that the western epi-corded-ware impulse that occurred at the stage of DDBC's cultural genesis was a short and single splash. The absence of further nourishment caused that impulse to fade and lose its features in the late DDBC's visual image.

Hence, external innovations in DDBC have rather convincing similarities in the environment of early Bronze cultures of central Europe and, possibly, of south-eastern Europe (Fig. 10). Then there is a logical question: how all those elements of the central European "fashion" reached the south of eastern Europe (the Northern Pontic Region) and were included in the DDBC's material complex and burial rite? Searching for an answer to that question, one should take into account that the central European sub-complex, identified within DDBC, is surprisingly practically absent in the western areas between the Carpathians and the Dnieper, i.e., the intermediary territories through which the impulse from the Carpathians and the Danube should have logically passed on its way to the Azov-Dnieper-Don Region, where the DDBC had been formed. Hence, Epi-Corded-Ware entities of Western Podolia and Volhynia (the Gorodok Zdovbytsya Mierzanowice culture, the Pochapy type, the Podolia group of pre-Carpathian culture and Strzyżów culture) demonstrate, to a different degree, individual elements (but never the entire set) of the central European sub-complex (Fig. 11): gender opposition in the burial rite, bronze torcs, binocular pendants, tin rolled beads; bone or shell buckle rings, segmented faience necklaces, flint arrow-heads with a grooved base [Sveshnikov 1974: 61, 66-67, 71-79, 111, 114, 127-128, 133-134, 137, 139, Fig. 15, 14-15; 23, 6, 8; 38, 3; 40, 1; 49, 2-12, 35, 36, 40; 1993: Fig. 3: IV; 4, 15, 24; Bargieł, Libera 2005: 198-200, Fig. 4, 4-7; 6, 6-12; 7, 2; Gedl 1985: 80-81, Plate XVII, 6, 8].

Also It is worthy of note that, the central European sub-complex in question was absolutely unrepresented in DPBC, which is territorially farther west, i.e., closer to the above Epi-Corded-Ware cultures of the Podolia and Volhynia and, therefore, to the presumed Carpathian-Danube source of its origin. This fact makes us look for some other way of penetration of the central European impulse from to the Azov-Dnieper-Don source of the DDBC cultural genesis, than the direct west-east vector from the Upper Carpathians. Possibly, the ambiguity of the situation is caused by the relative weakness and uneven archaeological investigation of the right-bank Ukrainian forest-steppe and Polissya.

It is worthy of note that, the central European Late Corded-Ware – Epi-Corded-Ware eastward splash had, most probably, not one, but at least two directions. First of them, farther north, went across the eastern European forest belt towards the North-East-East: approximately from the Northern Pre-Carpathian area to the Upper Volga Region, farther on to the Middle Volga and, possibly, even farther to the Pre-Urals.

Probably, that impulse left its traces in the funeral ritual (the gender opposition) and the material complex (bronze oculus-like pendants, jewellery made in the willow-leaf technique, etc.) of the cultures listed at the beginning of this article – the Balanovo, Fatyanovo, Middle Volga Abashevo and Volsk-Lbishcheno. The second direction, farther south, was most clearly represented by DDBC. Meanwhile, it had a rather different set of central European borrowings, which included items unknown in the eastern European forest cultures: bronze torcs, spiral bracelets, tin and spiral cylinders, bone buckles and archers' stone plates. Instead, unlike the Epi-Corded-Ware groups of the eastern European forest zone, the DDBC jewellery sets did not contain any wire objects made in the willow leaf technique, well-known in cultures of the Pre-Carpathian Epi-Corded-Ware culture circle [Kadrow 2000]. Possibly, this difference can be explained by the fact that both Epi-Corded-Ware impulses (the farther-north – forest and the farther-south – forest-steppe / steppe ones) had somewhat different primary epi-centres. Which exactly and where exactly in the Carpathian-Danube Region those primary epi-centres were located, remains a matter of further investigation. However, the “Epi-Corded-Ware” nature of those influences on eastern Europe causes practically no doubt.

In this connection, it is worth noting that the most recent studies have proved that the Babyno culture's anthropological type had been formed “on the basis of the population of eastern Corded-Ware cultures with the involvement of groups whose origin was connected with the territories of the Northern Caucasus and the Trans-Caucasus” [Kazarnitskiy 2013: 76]. The involvement of the Caucasian cultural phenomenon as the second external component of the Babyno cultural genesis has been also clearly fixed in the archaeological material [Lytvynenko 2007; 2009; 2011; 2012], however, that is a topic for a separate study.

*Translated by Inna Pidluska*



## REFERENCES

Agulnikov S.M., Popovich S.S.

2010 Obriad demembratsii v yamnoy kulture Pruto-Dnestrovskogo mezhdurechya. In: *Problemy okhrany i izucheniya pamiatnikov arkheologii stepnoy zony Vostochnoy Evropy. Sbornik statey*, 323-344. Lugansk.

Alekseeva I.L.

1992 *Kurgany epokhi paleometalla v Severo-Zapadnom Prichernomorje*. Kiev.

Alekseeva I.L., Bulatovich S.A.

1990 *Ohrannye istoriko-arkheologicheskie issledovaniya yugo-zapade Ukrainy*. Odessa, Zaporozhe: 35-48.

Antoniewicz V.

1929 Der in Stublo in Wolhynien aufgefundene Bronzeschatz. *Eurasia Septentrionalis Antiqua* 4: 135-148.

Andruk S.I., Dobroliubskiy A.O., Toshev G.N.

1985 *Kurgany u s. Plavni v nizoviakh Dunaya*. Moskva. (held in the Deponirovano v INION AN SSSR 13. 06. 85, № 21110).

Artemenko I.I.

1964 Neoliticheskie stoyanki i kurgany epokhi bronzy bliz s. Khodosovichy Gomelskoy oblasti BSSR. In: O.N. Bader (Ed.) *Pamiatniki kamennogo i bronzovogo vekov Evrazii*, 31-38. Moskva.

1967 Plemena Verkhnego i Srednego Podneprovya v epokhu bronzy. In: *Materialy i issledovaniya po arkheologii SSSR*, 148. Moskva.

1976 Mogilnik srednedneprovskoy kultury v urochische Strelitsa. In: S.S. Bezanskaya et al. (Eds) *Eneolit i bronzovyi vek Ukrainy. Issledovannya i materialy*, 69-96. Kyiv.

1987 Kultury shnurovoi keramiki: srednedneprovskaya, podkarpatskaya, gorodoksko-zdolbitskaya, stzhizhovskaya. In: O.N. Bader, D.A. Kraynov, M.F. Kosarev (Eds) *Epokha bronzy lesnoy polosy SSSR*, 35-51. Moskva.

Bader O.N., Khalikov A.Kh.

1987 Balanovskaya kultura. In: O.N. Bader, D.A. Kraynov, M.F. Kosarev (Eds) *Epokha bronzy lesnoy polosy SSSR*, 76-84. Moskva.

Bagińska J., Koman W.

2011 Wyniki badań kolejnych kurhanów kultury ceramiki sznurowej na Grzędzie Sokalskiej. In: H. Kowalewska-Marszałek, P. Włodarczak (Eds) *Kur-*

*hany i obrządek pogrzebowy w IV-II tysiącleciu p.n.e., 371-392. Kraków, Warszawa.*

Bandrivskyi M.

2011 Pokhovannia proto- i ranniounietytskoho typu na Verkhniomu Prydnisteri i problema Verkhniodunaiskykh vplyviv na Zakhid Ukrainskoho lisostepu vprodovzh periodiv BRA1-BRA2. *Materialy i doslidzhennia z arkeolohii Prykarpattia i Volyni* 15: 78-108.

Barich B.E.

1971 Il complesso industriale della stazione di Polada alla luce dei piu' recenti dati. *Bullettino di paleontologia Italiana* 80(22): 79-182.

Bargieł B., Libera J.

2005 Kultura strzyżowska na Lubelszczyźnie w świetle znalezisk grobowych In: V.V. Otroschenko (Ed.) *Na poshanu Sofiyi Stanislavivny Berezanskoyi, 197-211. Kyiv.*

Bartelheim M.

1998 Studien zur böhmischen Aunjetitzer Kultur – Chronologische und chronologische Untersuchungen. Teil 1, 2 [Aus dem Seminar für Ur- und Frühgeschichte der Freien Universität Berlin]. In: *Universitätsforschungen zur prähistorischen Archäologie*, 46. Bonn.

Bátora J.

1998 *Príspevok k otázke kultúrnych vzťahov územia juhozápadného Slovenska k oblasti severne od Karpát v závere staršej doby bronzovej.* In: A. Koško, J. Czembreszuk (Eds) „Trzciniac”: system kulturowy czy interkulturowy proces?, 259-265. Poznań.

2006 *Štúdie ku komunikácii medzi strednou a Východnou Európou v dobe bronzovej.* Bratislava.

Bende L., Lörinczi G.

2002 Kora bronzkori temető és település a Kiskundorozmai Hosszúhát-Halm-on. In: *Studia archaeologia VIII: 77-107. Szeged.*

Benešova A.

1956 Nález měděných předmětů na Starých Zamcích v Brně-Lišni. *Památky Archeologické* 47: 236-244.

Berestnev S.I.

2001 *Vostochnoukrainskaya lesostep v epokhu sredney i pozdney bronzy (II tys. do n. e.).* Kharkov.

Berezanska S.S. = Berezanskaya S.S.

- 1964 Keramika bilohrudivskoyi kultury (za materialamy rozkopok bilia s. Sobkivka). *Arkheolohiya* 16: 49-75.
- 1986 Kultura mnogovalikovoy keramiki. In: S.S. Berezanskaya, V.V. Otroshchenko, N.N. Cherednichenko, I.N. Sharafutdinova (Eds) *Kultury epokhi bronzy na territorii Ukrainy*, 6-46. Kyiv.
- 1999 Mogilnik epokhi bronzy Gordeevka na Yuzhnom Buge. *Rossiyskaya arkheologiya* 4: 131-148.

Berezanskaya S.S., Gershkovich Ya.P.

- 1983 Andronovskie elementy v srubnoy kulture na Ukraine. *Bronzovyi vek stepnoy polosy Uralo-Irtyshskogo mezhdurechia*. 100-110. Cheliabinsk.

Berezanska S.S., Hoshko T.J., Samoliuk V.O.

- 2004 Kolektyvne pokhovannia tshinetskoyi kultury na r. Horyn. *Arkheolohiya* 1: 111-125.

Berezanskaja S.S., Kločko V.I

- 1998 Das Gräbfeld von Hordeevka. Archäologie in Eurasien. Band 5, Rahden/West.

Berezanskaya S.S., Lobay B.I.

- 1987 *Otchet o raskopkakh mogilnika epokhi bronzy u s. Gordeevka Trostianetskoj rayona Vinnitskoj oblasti* (held in the archives of IA NANU).

Berezanska S.S., Otroshchenko V.V.

- 1997 Bronzovyi vik. In: P. Tolochko (Ed.) *Davnia istoriya Ukrainy, vol. 1*, 384-544. Kyiv.

Berezanska S., Samoljuk W., Taras H.

- 2003 Cmentarzysko kurhanowe kultury trzcienieckiej z okolic Netišyna na Wołyniu (grupa I). *Archeologia Polski Środkowowschodniej* 6: 184-214.

Bertemes F.

- 1989 Das frühbronzezeitliche Gräberfeld von Gemeinlebarn. *Saarbrücker Beiträge zur Altertumskunde*, 45.

Bidzilia V. I., Yakovenko E. V.

- 1973 Ralo iz pozdneyamnogo pogrebeniya kontsa III – nachala II tysiacheletiya do n. e. *Sovetskaya arkheologiya* 3: 146-152.

Blajer W.

- 1990 Skarby z wczesnej epoki brązu na ziemiach polskich. In: *Prace Komisji Archeologicznej PAN*, 28. Wrocław.

- 1998 Przyczynek do dyskusji o znaczeniu metalurgii brązu w zachodnim odłamie kultury trzcinieckiej. In: A. Koško, J. Czebreszuk (Ed.) „Trzciniec”: *system kulturowy czy interkulturowy proces?*, 337-342, Poznań.
- 2000 Drugi sezon ratowniczych badań wykopaliskowych na stanowisku 5 w Lipniku, pow. Przeworsk (stan. 155 na obszarze 104-79), *Rocznik Przemyski* (1), *Archeologia*: 37-50.

Bona I.

- 1975 *Die Mittlere Bronzezeit Ungarns und ihre südöstlichen Beziehungen*. Budapest.

Bondar N.N.

- 1974 *Poseleniya Srednego Podneprovya epokhi ranney bronzy*. Kyiv.

Borziyak I.A., Manzura I.V., Levickij O.G.

- 1983 *Korzhevskie kurgany. Arheologicheskie issledovaniya v Moldaviiv 1979 – 1980 gg.* Kishinev: 3-27.

Bratchenko S.N.

- 1976 *Nizhnee Podonie v epokhu sredney bronzy (periodyzatsia i khronologiya pamiatnikov)*. Kyiv.
- 1977 K voprosu o slozhenii babinskoy kultury (mnogovalikovoy keramiki). In: D.Ya. Telegin (Ed.) *Vilnianskie kurgany v Dneprovskom Nadporozhe*, 21-43. Kyiv.
- 2001 *Donetska katakombna kultura rannioho etapu, vol. 1*. Luhansk.
- 2003 Radiocarbon chronology of the Early Bronze Age of the Middle Don. Svatove, Luhansk Region. In: A.Koško, V.I. Klochko (Ed.) *The Foundations of Radiocarbon Chronology of Cultures between the Vistula and Dnieper: 4000-1000 BC. Baltic-Pontic Studies* 12: 185-208.
- 2004 Pradavnia Slobozhanschyna: Svativsky mohyly-kurhany III tys. do n. e. ta maydany. In: *Materialy ta doslidzhennia z arkeolohiyi Skhidnoyi Ukrainy* 2: 65-190. Luhansk.
- 2012 *Leventsovskaya krepost*. Kyiv.

Bratchenko S.N., Balonov F.R., Gershkovich Ya.P.

- 2004 Drevneyshaya gruppa pogrebeniy Aleksandrovsckogo kurgana № 9 na r. Lugan. In: *Materialy ta doslidzhennia z arkeolohiyi Skhidnoyi Ukrainy*: 30-74. Luhansk.

Bratchenko S. N., Shaposhnikova O. G.

- 1985 Katakombnaya kulturno-istoricheskaya obschnost. In: I.I. Artemenko, S.S. Berezanskaya, V.D. Baran, V.A. Anokin (Eds) *Archeologia Ukrain-skoy SSR*, vol. 1: 403-419. Kyiv.



Braudel F.

- 1992 *Kultura materialna, gospodarka i kapitalizm XV-XVIII wiek. Tom 3. Czas trwania.* Warszawa.

Bronzezeit

- 2013 *Bronzezeit. Europa ohne Grenzen 4. – 1. Jahrtausend v. Chr. Ausstellungskatalog.* Sankt Petersburg.

Brovender Yu.M.

- 2009 Copper Ores of the Northern Pontic Region as Raw Materials for Production Activity in the Paleometal Age (Based on the Study of the Kartamysh Ore Mining and Metallurgy Complex). In: A. Koško, V. Klochko (Ed.) *Routes between the Seas: Baltic-Bug-Boh-Pont from the 3rd to the Middle of the 1st Millennium BC. Baltic-Pontic Studies* 14: 103-123.

Brovender Yu.M., Otroschenko V.V., Priakhin A.D.

- 2010 Kartamyskyi kompleks hirnycho-metalurhiynykh pamiatok bronzovoho viku v Tsentralnomy Donbasi. *Arkheolohiya* 2: 87-101.

Buchvaldek M.

- 1958 Hroby se šnurovou keramikou ze Sulejovic. *Památky archeologické* 49(1): 15-39.
- 1966 Die Schnurkeramik in Mitteleuropa – Zur Herausstellung der Fundgruppen und der Frage ihrer gegenseitigen Beziehungen. *Památky archeologické* 57(1): 126-171.
- 1987 Sredneevropeyskaya shnurovaya keramika i Severnoe Prichernomorie (k probleme khronologicheskikh i kulturnykh svyazey). In: K.N. Pitskhelauri, E.N Chernykh (Eds) *Kavkaz v sisteme paleometallicheskh kultur Evrazii*, 224-234. Tbilisi.
- 1997 Die südosteuropäischen Elemente in der Schnurkeramik. In: C. Becker, M.L. Duneklmann *et al.* (Eds) *Chronos. Beiträge zur prähistorischen Archäologie zwischen Nord- und Südosteuropa*, 181-185. Espelkamp.

Budziszewski J., Tunia K.

- 2000 A grave of the Corded Ware Culture arrowheads producer in Koniusza, Southern Poland. In: S. Kadrow (Ed.) *A Turning of Ages. Im Wander der Zeiten. Jubilee Book Dedicated to Professor Jan Machnik on His 70th Anniversary*, 127-130. Kraków.

Budziszewski J., Włodarczak P.

- 2010 *Kultura pucharów dzwonowatych na Wyżynie Małopolskiej.* Kraków.

Bukowski Z.

- 1976 *Elementy wschodnie w kulturze łużyckiej u schyłku epoki brązu.* Wrocław.

Buniatian K.P.

2010 Pidkarpatska kultura shnurovoyi keramiky. *Arkheolohiya* 2: 18-30.

Buniatian K.P., Kaiser E., Nikolova A.V.

2006 *Bronzezeitliche Bestattungen aus dem Unteren Dneprgebiet*. Langenweissbach.

Buniatian K.P., Samoliuk V.

2009 Manifestations of Middle Dnieper Culture in the Volyn Territory and the Issue of Ancient Routes. In: A. Koško, V.I. Klochko (Ed.) *Routes between the Seas: Baltic-Bug-Boh-Pont from the 3rd to the Middle of the 1st Millennium BC*. *Baltic-Pontic Studies* 14: 252-268.

Burtănescu F.

2002 *Epoca timpurie a bronzului între Carpați și Prut cu unele contribuții la problemele perioadei premergătoare epocii bronzului în Moldova*. București.

Bychkov N.V.

1982 *Otchet o polevykh issledovaniyakh v 1982 g.* (held in the archives of II NANB, nr. 843).

1983a *Otchet o polevykh issledovaniyakh v 1983 g.* (held in the archives of II NANB, nr. 870).

1983b *Planovaya tema za 1983 god* (held in the archives of II NANB, nr. 1275).

1985 *Issledovaniya v Gomelskoy oblasti*. In: *Arkheologicheskie otkrytiya 1983 goda*, 383. Moskva.

1989 *Planovaya tema za 1986-1989 gody* (held in the archives of II NANB, nr. 1124).

Cabalska M.

1980 *Związki między kulturą Otomani a kulturą trzciniecką*. *Archeologia Polski* 29: 53-65.

Catling H.W.

1964 *Cypriot bronzework in the Mycenaean world*. Oxford.

Chebotarenko G.F., Yarovoj E.V., Telnov N.P.

1989 *Kurgany Budzhakskoj stepi*. Kishinev.

Cherniakov I.T.

1979 *Kulturno-khronologicheskoe svoeobrazie pamiatnikov epokhi bronzy Severo-Zapadnogo Prichernomoria*. In: *Problemy epokhi bronzy yuga Vostochnoy Evropy: tezisy dokladov konferentsii; Donetsk 3-6 dekabria 1979 g.*, 8-10. Donetsk.

- 1996 Kultura mnogovalikovoi keramiki – vostochnyi areal balkano-dunaiskogo ochaga kulturogeneza. In: *Severo-Vostochnoe Priazovie v sisteme evraziyskikh drevnostey (eneolit - bronzovyi vek. Materialy mezhdunarodnoy konferentsii, vol. 1, 59-64. Donetsk.*

Chernykh E.N.= Chernykh Y.N.

- 1967 *Istoriya drevneyshey metallurgii Vostochnoy Evropy. Moskva*  
 1976 *Drevniyametalloobrabotka na Yugo-Zapade SSSR. Moskva.*  
 1978 *Gornoe delo i metallurgiya v drevneyshey Bolgarii. Sofia.*  
 1992 *Ancient Metallurgy in the USSR. The Early Metal Age. Cambridge.*

Chernykh E.N., Avilova L.L., Orlovskaya L.B.

- 2000 *Metalurgicheskie printsii i radiouglerodnaya khronologiya. Moskva*

Chernykh E.N., Orlovskaya L.B.

- 2004 Radiouglerodnaya khronologiya katakombnoy kulturno-istoricheskoy obschnosti (sredniy bronzovyi vek). *Rossiyskaya Arkheologiya 2:15-29.*

Chernykh L.A.

- 2003 O vozmozhnosti ispolzovaniya medno-rudnikh istochnikov Donbassa v period eneolita, runney i sredney bronzy. In: *Problemy girnichoyi archeologii. 212-223. Alchevsk.*  
 2011 Bronzovye nozhi iz pamiatnikov katakombnoy KIO Ukrainy (klassifikatsia po vyborke predmetov – predvaritelnye itogi). In: *Problemy hirnychoi arkheologii (Materialy VIII-ho mizhnarodnoho Kartamyskoho poliovoho seminaru), 23-79. Alchevsk.*

Chernykh L.A., Pleshivenko A.G.

- 1993 Pogrebeniye liteyshchika katakombnoy kultury u s. Vasilievka. In: *Khoziaystvo drevnego naseleniya Ukrainy, vol. 2, 244-267. Kyiv.*

Chomentowska B.

- 1964 Masowy grób kultury trzcienieckiej w Kosinie, pow. Kraśnik. *Światowit 24: 237-251.*

Ciugudean H.

- 2011 Mounds and Mountains: Burial Rituals in Early Bronze Age Transylvania. In: Berecki S.; Németh R.E.; Rezi B. (Eds). *Bronze Age Rites and Rituals in the Carpathian Basin: 21-59. Târgu Mureş.*

Coirvuc V., Dumitroaia G. (Eds)

- 2001 *Cultura Costişa în contextul epocii bronzului din România. Piatra-Neamţ.*

Czopek S.

- 1996 *Grupa tarnobrzaska nad środkowym Sanem i dolnym Wisłokiem*. Rzeszów.
- 2003 Między Południem a Wschodem – importy i naśladownictwa ceramiki w materiałach grupy tarnobrzaskiej. In: J. Gancarski (Ed.) *Epoka brązu i wczesna epoka żelaza w Karpatach polskich*, 215-238. Krosno.

Dascălu L.

- 2007 *Bronzul mijlociu si tarziu in Campia Moldovei*. Iasi.

Dashevska O.D., Golentsov A.S.

- 2003 Zakhidnodonuzlavskiy kurhan doby bronzы. *Arkheolohiya* 3: 5-15.

David V.

- 2002 *Studien zu Ornamentik und Datierung der bronzezeitlichen Depotfundgruppe Hajdúsámson-Apa-Ighiel-Zajta*. Alba Iulia-Karlsburg/Weissenburg.

Dąbrowski J.

- 1977 Oddziaływania śląsko-wielkopolskie na metalurgię kultury trzcinieckiej. In: B. Gediga (Ed.) *Geneza kultury łużyckiej na terenie Nadodrza*, 201-224. Wrocław.
- 2004 *Ältere Bronzezeit in Polen*. Warszawa.
- 2009 *Polska przed trzema tysiącami lat. Czasy kultury łużyckiej*. Warszawa.

Dąbrowski J., Okuliczowa Ł.

- 1962 Skarb brązowy ze Stawiszyc, pow. Pińczów. *Wiadomości Archeologiczne* 28: 243-250.

Dergachev V.A.

- 1986 *Moldaviya i sosednie territorii v epokhu bronzы*. Kishinev.
- 1994 Epoca bronzului. Perioada timpurie. *Thraco-Dacica* 15(1-2): 121-140.
- 1998 Entwicklungen im Raum zwischen Karpaten und Dnepr. In: B. Hänsel, J. Machnik (Eds) *Das Karpatenbecken und die osteuropäische Steppe*, 27-64. München.
- 1999 Osobennosti kulturno-istoricheskogo razvitiya Karpato-Podnestrovia. K probleme vzaimodeystviya drevnikh obschestv Sredney, Yugo-Vostochnoy i Vostochnoy Evropy. *Stratum plus* 2: 169-221.
- 2011 *Topory-kelty pozdney bronzы Karpato-Podunavia, vol. 2*. Chişinău.

Dergachev V.A., Bochkarev V.S.

- 2002 *Metallicheskie serpy pozdney bronzы Vostochnoy Evropy*. Chişinău.

Dergachev V.A., Savva E.N.

- 1985 Raskopki kurganov u s. Kotjala. In: *Archeologicheskie issledovaniya v Moldavii* (1981 g.), 64-82. Kishinev.

- Diachenko O.V.  
2007 Problema istorychnykh interpretatsiy trypils'koi kultury. *Arkheolohiya* 2:83-91.
- Dobrzańska H., Rydzewski J.  
1992 Elementy zakarpackie w materiałach kultury trzcinieckiej w Mysławczycach. *Acta Archaeologica Carpatica* 31: 91-106.
- Dovzhenko N.D.  
1991 Kamiani statui v pokhovalnomu obriadi katakombnykh plemen Pivnichnoho Prychornomia. In: M.M. Bondar (Ed.) *Pokhovalnyi obriad davnioho naseleння Ukrainy*, 122-133. Kyiv.
- Dovzhenko N.D., Soltis O.B.  
1991 O traditsii izobrazheniya "stop" v pogrebalnom obriadye katakombnykh kultur Severnogo Prichernomia. In: *Katakombnye kultury Severnogo Prichernomia*, 117-127. Kyiv.
- Dresely, V.  
2004 *Schnurkeramik und Schnurkeramiker im Taubertal*. Stuttgart.
- Dresely V., Müller J.  
2001 Die absolutchronologische Datierung der Schnurkeramik im Tauber-und Mittel-Elbe-Saale-Gebeit. In: J. Czebruszek, J. Müller (Eds) *Die absolute Chronologie im Mitteleuropa 3000–2000 v. Chr. Studien zur Archäologie in Ostmitteleuropa*, vol. 1, 287-318. Poznań–Bamberg.
- Dumitroaia Gh.  
2000 *Comunități preistorice din nord-estul României. De la cultura Cucuteni până în bronzul mijlociu*. Piatra-Neamț.
- Duffy P. R.  
2010 *Complexity and autonomy in Bronze Age Europe: assessing cultural developments in Eastern Hungary: a dissertation submitted for the degree of Doctor of Philosophy (Anthropology)*. Michigan
- Dvorianinov S.A., Petrenko V.G., Rychkov N.A.  
1981 K izucheniyu orientirovki yamnykh pogrebeniy. In: V.N. Stanko (Ed.) *Drevnosti Severo-Zapadnogo Prichernomia*, 22-38. Kyiv.
- Egg M.  
1992 Zur Ausstattung des Toten vom Hauslabjoch, Gem. Schnals (Sudtirol). In: F. Hopfel, W. Platzer, K. Spindler (Eds) *Der Mann im Eis*, 254-272. Innsbruck.

Evdokimov G.L.

- 1980 O kulturno-khronologicheskikh razlichiyakh katakombnykh pamiatnikov Nizhnego Podneprovia, Priazovia i Kryma. In: *Arkheologicheskie issledovaniya na Ukrainie v 1978-1979 gg. Tezisy dokladov XVIII konferentsii IA AN USSR*, 48-50. Dnepropetrovsk.
- 1987 K voprosu o roli donetskoj katakombnoy kultury v slozhenii katakombnykh kultur Severnogo Prichernomorja. In: *Problemy okhrany i issledovaniya pamiatnikov arkheologii v Donbasse. Tezisy*, 46-48. Donetsk.

Fasani L.

- 1984 L'età del Bronzo. In: A. Aspes (Ed.) *Veneto nell'antichità, Preistoria e Protostoria*, vol. II, 451-533. Verona.
- 1988 La sepoltura e il forno di fusione La Vela di Valbusa (Trento). *Preistoria Alpina* 24: 165-181. Trento.

Feschchenko E.L.

- 1992 Izdelia iz metalla v katakombnykh pogrebeniyakh Dneprovskogo predstepiya. In: *Problemy arkheologii Podneprovia*, 84-101. Dnepropetrovsk.

Florescu M.

- 1964 Contributii la cunoașterea culturii Noua. *Arheologia Moldovei* 2-3: 143-216.
- 1970 Problèmes de la civilisation de Costișa à la lumière du sandage de Borlești. *Dacia* 14: 51-81.

Fokkens H., Achterkamp Y., Kuijpers M.

- 2008 Bracers or Bracelets? About the Functionality and Meaning of Bell Beaker Wrist-guards. *Proceedings of the Prehistoric Society* 74: 109-140.

Furmánek V., Veliačik L., Vladár J.

- 1991 *Slovensko v dobe bronzovej*. Bratislava.

Gajewski L.

- 1969 Fin du néolithique - début de la période de Hallstatt. *Inventaria Archaeologica Pologne* 22: Planche 130-136.

Gancarski J.

- 1994 Pogranicze kultury trzcienieckiej i Otomani-Füzesabony – grupa jasielska. In: *Problemy kultury trzcienieckiej*, 75-104. Rzeszów.
- 1999 Chronologia grupy pleszowskiej kultury mierzanowickiej i kultury Otomani-Füzesabony w Polsce na podstawie wyników badań wykopaliskowych osad w Trzciniicy i Jaśle. In: J. Gancarski (Ed.) *Kultura Otomani-Füzesabony – rozwój, chronologia, gospodarka*, 145-180. Krosno.
- 2011 *Trzcinica – karpacka Troja*. Krosno.

- Gancarski J. (Ed.)  
2002 *Między Mykenami a Bałtykiem. Kultura Otomani-Füzesabony*. Krosno-Warszawa
- Gardawski A.  
1959 Plemiona kultury trzcinieckiej w Polsce. *Materiały Starożytne* 5: 7-189.
- Gardawski A., Wesołowski K.  
1956 Zagadnienie metalurgii kultury trzcinieckiej w świetle „skarbów” z Dratowa, pow. Puławy i Rawy Mazowieckiej. *Materiały Starożytne* 1: 59-103.
- Gebers W.  
1978 Endneolithicum und Frühbronzezeit im Mittelrheingebiet. Katalog. *Saarbrücker Beiträge zur Altertumskunde* 28.
- Gedl M.  
1975 *Kultura przedłużycka*. Wrocław-Warszawa-Kraków-Gdańsk.  
1985 *Epoka brązu i wczesna epoka żelaza w Europie*. Kraków.
- Gening V.V., Korpusova V.N.  
1989 *Arkheologicheskie pamyatniki Krymskogo Prisivashya*. Kurgany u s. Istochnoe i s. Bolotnoe. Kiev
- Gershkovich Ya.P.  
1997 Proiskhozhdeniye i evolutsiya sabatinovskogo keramicheskogo kompleksa. *Arkheologicheskiy almanakh* 6: 125-144.
- Gey A.N.  
2000 *Novotitorovskaya kultura*. Moskva.  
2011 Spornye voprosy i perspektivy izucheniya katakombnoy kulturno-istoricheskoy obshchnosti. *Kratkie soobscheniya Instituta Arkheologii* 225: 3-10.
- Gimbutas M.  
1965 *Bronze Age Cultures in Central and Eastern Europe*. Paris-Hague-London.
- Girić M.  
1971 Mokrin: nekropola ranog bronzanog doba. In: *Dissertationes et monographiae XI*. Beograd.
- Glosik J.  
1968 Kultura strzyżowska. *Materiały Starożytne* 11.
- Gorodtsov V.A.  
1905 Rezultaty arkheologicheskikh issledovaniy v Iziumskom uezdie Kharkovskhoy gubernii 1901 goda. In: *Trudy XII Arkheologicheskogo Syezda*, vol. 1, 174-225. Moskva.

Goshko T., Manichev V., Pryimachenko V., Bondarenko I.

- 2009 Doslidzhennia kolorovoho metalu doby piznioi bronzы z terytorii Pravoberezhnoi lisostepovoї Ukrainy. In: V.V. Otroschenko (Ed.) *Vzaemozviazky kultur epokh bronzы i rannoho zaliza na terytorii Tsentralnoi ta Skhidnoi Evropy. Zbirka naukovykh prats na poshanu Larysy Ivanivny Krushelnytskoi*, 99-118. Kyiv, Lviv.

Górski J.

- 1994 Materiały kultury trzcinieckiej z kopca wschodniego w Rosiejowie. *Materiały Archeologiczne Nowej Huty* 17: 41-64.
- 1995 Grób z początków starszego okresu epoki brązu ze stanowiska 17 w Nowej Hucie-Pleszowie. *Materiały Archeologiczne Nowej Huty* 18: 17-21.
- 1998 Transkarpackie kontakty ludności zachodniej Małopolski w początkach epoki brązu w świetle najnowszych odkryć w Karpatach (próba interpretacji niektórych znalezisk). In: J. Gancarski (Ed.) *Dzieje Podkarpacia* vol. 2, 201-214. Krosno.
- 1999 Die Beziehungen zwischen dem westlichen Kleinpolen und dem Gebiet der Slowakei in der klassischen Phase der Trzciniec-Kultur (ausgewählte Aspekte). In: J. Batora, J. Peska (Eds) *Aktuelle Probleme der Erforschung der frühbronzezeit in Böhmen und Mähren in der Slowakei*, 251-265. Nitra.
- 2003 Uwagi o datowaniu i kontekście znalezisk ceramiki o „cechach południowych” w strefie zasięgu kultury trzcinieckiej. In: J. Gancarski (Ed.) *Epoka brązu i wczesna epoka żelaza w Karpatach polskich*, 89-137. Krosno.
- 2007 *Chronologia kultury trzcinieckiej na lessach niecki nidziańskiej*. Kraków.
- 2012 Transcarpathian elements in the Trzciniec culture. Wanderings of people or ideas? In: R. Kujovský, V. Mitáš (Eds) *Václav Furmáněk a doba bronzová. Zborník k 70. Narodeninám*, 89-97. Nitra.

Górski J., Jarosz P.

- 2006 Cemetery of the Corded Ware and the Trzciniec Cultures in Gabułów. *Sprawozdania Archeologiczne* 58: 401-453.

Górski, J., Lysenko, S., Makarowicz, P.

- 2003 Radiocarbon Chronology of the Trzciniec Cultural Circle between the Vistula and Dnieper Basins. In: A.Koško, V.I. Klochko (Ed.) *The Foundations of Radiocarbon Chronology of Cultures between the Vistula and Dnieper: 4000-1000 BC. Baltic-Pontic Studies* 12: 253-306.

Górski P., Makarowicz P.

- 2007 Reception of Transcarpathian influence in Trzciniec Cultural Circle as a Sign of Long-Distance Exchange Contacts. In: J. Baron, I. Lasak (Eds) *Long Distance Trade in the Bronze Age and Early Iron Age*, 101-116. Wrocław.



- Górski J., Makarowicz P., Wawrusiewicz A.  
2011 *Osady i cmentarzyska społeczności trzcinieckiego kręgu kulturowego w Polesiu, stanowisko I, województwo łódzkie*. Łódź.
- Górski J., Wróbel J.  
2000 Zbiorowy grób szkieletowy kultury trzcinieckiej z Nowej Huty-Cła, stan. 65. *Materiały Archeologiczne Nowej Huty* 22: 21-34.
- Grigoriev S.A.  
2002 *Ancient Indo-Europeans*. Cheliabinsk.
- Grygiel R.  
1987 Z badań nad kulturą trzciniecką w rejonie Brześcia Kujawskiego. In: *Kultura trzciniecka w Polsce*, 73-88. Kraków.
- Hafner A., Suter P.J.  
2003 Vom Endneolithikum zur Frühbronzezeit: Wandel und Kontinuität zwischen 2400 und 1500 V. Chr. *Archäologisches Korrespondenzblatt* 33 (3): 325-339.
- Harrison R.J., Heyd V.  
2007 The Transformation of Europe in the Third Millennium BC: The Example of 'Le Petit Chasseur I+III' (Sion, Valais, Switzerland). *Praehistorische Zeitschrift* 82 (2): 129-214.
- Heyd V.  
2011 Yamnaya Groups and Tumuli West of the Black Sea. In: E. Borgna, S. Müller-Celka (Eds) *Ancestral Landscapes: Burial mounds in the Copper and Bronze Ages*, 529-549. Lyon.
- Honti S., Kiss V.  
2013 Bronze hoard from Zalasabár. New Data on the Study of the Tolnanémedi Horizon – Part 2. In: A. Anders, G. Kulcsár *et al.* (Eds) *Moments in Time. Papers presented to Pál Raczky on His 60th Birthday*, 739-755. Budapest.
- Hundt H.J.  
1958 Katalog Straubing I. Die Funde der Glockenbecher-kultur und der Straubinger Kultur. In: *Materialhefte zur Bayerischen Vorgeschichte* 11(1). München.
- Hübner E.  
2005 *Jungneolithische Gräber auf der jütischen Halbinsel. I: typologische und chronologische Studien zur Einzelgrabkultur*. København
- Ignaczak M., Koško A., Szmyt M. (Eds)  
2011 *Między Bałtykiem a Morzem Czarnym. Szlaki międzymorza IV–I tys. przed Chr. Archeologia Bimaris. Dyskusje 4*. Poznań

Iliukov L.C.

- 1985 Pogrebeniya lityeshikov epokhi sredney bronzы iz Severo-Vostochnogo Priazovia. *Sovetskaya Arkheologiya* 2: 226-231.

Isaenko V.F.

- 1976 *Neolit Pripiatskogo Polesiya*. Minsk.

Isaenko V.F., Cherniavskiy M.M.

- 1967 Novye dannye po spornym voprosam bronzovogo veka Belorussii. In: *Belorusskie drevnosti*, 155-181. Minsk.

Ivanova S.V.

- 2010 Torgovye puti i migratsii v Yugo-Vostochnoy Evrope v rannem bronzovom veke. *Materialy po archeologii Severnogo Prichernomoria* 11: 158-248.
- 2013 Kulturno-istoricheskie kontakty naseleniya Severo-Zapadnogo Prichernomoria v rannem bronzovom veke: Zapad-Vostok. Kulturno-istoricheskie kontakty naseleniya. *Stratum plus* 2: 158-248.

Ivanova S.V., Ostroverkhov A.S., Savelev O.K., Ostapenko P.V.

- 2012 *Ocherki istorii i arkheologii Dnestro-Bugskogo mezhdurechia*. Kyiv.

Ivanova S.V., Petrenko V.G. Vetchinnikova N.E.

- 2005 *Kurgany drevnikh skotovodov mezhdurechia Yuzhnogo Buga i Dnestra*. Odessa.

Ivanova S.V. Savelev O.K.

- 2011 Kurgan bilya s. Sichavka Odeskoї oblasti. *Arheologiya* 3: 70-82.

Kadrow S. =Kadrov S.

- 1995 *Gospodarka i społeczeństwo. Wczesny okres epoki brązu w Małopolsce*. Kraków.
- 1998 Osteuropäische Beziehungen des epischurkeramischen karpatenländischen Kulturkreises in der Frühbronzezeit. In: B. Hänsel, J. Machnik (Eds) *Das Karpatenbecken und die osteuropäische Steppe*, 251-260. München.
- 2000 Wczesnobrązowa wytwórczość metalurgiczna w stylu wierzbowego liścia. In: J. Rydzewski (Ed.) *150 lat Muzeum Archeologicznego w Krakowie*, 141-153. Kraków.
- 2001 *Uprogu nowej epoki. Gospodarka i społeczeństwo wczesnego okresu epoki brązu w Europie Środkowej*. Kraków.

Kadrow S., Górski J.

- 2003 Diachronic Micro-Regional Studies concerning Settlement on the Loess Uplands of Southeastern Poland in the Bronze Age. In: H. Thrane (Ed.) *Diachronic Settlement Studies in the Metal Ages*, 71-97. Aarhus.

Kadrow S., Machnik J.

- 1997 *Kultura mierzanowicka. Chronologia, taksonomia i rozwój przestrzenny.* Prace komisji archeologicznej. 29. Kraków.

Kaiser E.

- 1997 Der Hort von Borodino. In: *Universitätsforschungen zur prähistorischen Archäologie* 44. Berlin.
- 2003 Studien zur Katakombengrabkultur zwischen Dnepr und Prut. In: *Archäologie in Eurasien* 14. Mainz.
- 2009 Problemy absolutnogo datirovaniya katakombnoy kultury Severnogo Prichernomoria. *Tyragetia (serie nouă)* 3 (18/1): 59-70.
- 2012 Problemy absolutnogo datirovaniya katakombnoy kultury Severnogo Prichernomoria. *Kratkie soobscheniya Instituta Arkheologii* 225: 15-27.

Kaiser E., Plešivenko A.G.

- 2000 Die bronzezeitlichen Grabsitten im unteren Dneprgebiet. *Eurasia Antiqua* 6: 125-208.

Kalicz N.

- 1968 *Die Frühbronzezeit in Nordostungarn.* Budapest.

Kalicz-Schreiber R.

- 1989 *Die älteste Bronzezeit in Nordwestungarn und ihre Beziehungen.* Praehistorica. XV–XIV: 249-255.

Katincharov R.

- 1987 Ranniy bronzovyi vek Frakii i ego kulturnye sviazi i vzaimootnosheniya s sosednimi oblastiami. In: K.N. Pitskhelauri, E.N Chernykh (Eds) *Kavkaz v sisteme paleometallicheskih kultur Evrazii*, 168-175. Tbilisi.

Kazarnitskiy A.A.

- 2013 Kraniologia naseleniya babinskoy kultury. *Vestnik arkheologii, antropologii i etnografii* 2 (21): 70-78.

Kamenskij A.G.

- 1990 Rezultaty spektralnogo i metallograficheskogo issledovaniya metallicheskih predmetov iz pamyatnikov epoxi bronzы s territorii Moldovy (Prilozhenie 5). In: E.V. Yarovoj (Ed.) *Kurgany eneolita-bronzы Nizhnego Podnestrovyia. Kishinev*, 247-258.

Kempisty A.

- 1978 *Schyłek neolitu i początek epoki brązu na Wyżynie Małopolskiej w świetle badań nad kopcami.* Warszawa.

Kiyashko A.V.

- 1999 *Proiskhozhdeniye katakombnoy kultury Nizhnego Podonia.* Volgograd.

## Klein L.S.

- 1962 Katakombnye pamiatniki epokhi bronzy i problema vydeleniya arkheologicheskikh kultur. *Sovetskaya arkheologiya* 2: 26-38.
- 1970 Katakombnaya kultura ili katakombnye kultury? In: B.A. Kolchin, Ya.A. Sher (Eds) *Statistiko-kombinatornye metody v arkheologii*, 165-179. Moskva.
- 1975 Retsenziya na: Kurgany stepnoy chasti mezhdurechia Dunaya i Dnestra. *Sovetskaya arkheologiya* 1: 297-304.

## Klochko E.O

- 1990 Redkiy pogrebalnyi kompleks katakombnoy kultury na Srednom Dnestre. In: O.G. Shaposhnikova, V.V. Otroschenko, S.Z. Pustovalov, G.N. Toshev, G.I. Shapovalov (Eds) *Problemy izucheniya katakombnoy kulturno-istoricheskoy obschnosti*, 28-30. Zaporozhie

## Klochko V.I.

- 1994 Metallurgicheskoe proizvodstvo v eneolite-bronzovom veke. In: I.T. Cherniakov (Ed.) *Remeslo epokhi eneolita-bronzy na Ukraine*, 96-132. Kyiv.
- 1998 „Loboykivska metalurhiya” (do problemy skhidnoho kordonu skhidnotshynetskoj kultury). In: A.Koško, J.Czebreszuk (Eds) „*Trzciniac*”: *system kulturowy czy interkulturowy proces?*, 217-237. Poznań.
- 2001 Weaponry of Societies of the Northern Pontic Culture Circle: 5000-700 BC. *Baltic-Pontic Studies* 10.
- 2004 Metalurhiya trypilskoj kultury (dosiahnennia ta perspektyvy vyvchennia). In: M.Videiko (Ed.) *Entsyklopediya trypilskoj tsyvilizatsiyi I*: 219-222. Kyiv.
- 2006 *Ozbroyennia ta viyskova sprava davnoho naseleння Ukrainy (5000-900 r. do R.Kh.)*. Kyiv.
- 2008 Torhovelnii shliakh Bug-Bog. In: J. Bednarczyk, J. Czebreszuk, P. Makarowicz, M. Szmyt (Eds) *Na pograniczu światów. Studia z pradziejów międzymorza bałtycko-pontyjskiego ofiarowane Profesorowi Aleksandrowi Koško w 60. rocznicę urodzin*, 239-249. Poznań.
- 2012 „Hordiyivskiy fenomen”. In: W. Blajer (Ed.) *Peregrinationes archaeologicae in Asia et Europa Joanni Chochorowski dedicatae*, 395-404. Kraków.

## Klochko V.I., Koško A.

- 2009 The Societies of Corded Ware Cultures and Those of Black Sea Steppes (Yamnaya and Catacomb Grave Cultures) in the Route Network Between the Baltic and Black Seas. In: A. Koško, V.I. Klochko (Eds) *Routes between the Seas Baltic-Bug-Boh-Pont from the 3rd to the Middle of the 1st Millennium BC*. *Baltic-Pontic Studies* 14: 269-301.

Klochko V.I., Koško A., Szmyt M.

- 2003 A comparative chronology of the Prehistory of the area between the Vistula and Dnieper: 4000-1000 BC. In: A. Koško, V.I. Klochko (Eds) *The Foundations of Radiocarbon Chronology of Cultures between the Vistula and Dnieper: 4000-1000 BC. Baltic-Pontic Studies* 12: 396-414.

Klochko V.I., Kozymenko A.V.

- 2011 *Nash nedavniy bronzovyi vek*. Kyiv.

Klochko V.I., Kravets D.P.

- 1991 K absoliutnoy khronologii kultury mnogovalikovoy keramiki. In: M.T. Kaszuba (Ed.) *Drevneyshie obshchnosti zemledeltsev i skotovodov Severnogo Prichernomia (5000 do n.e. – 500 n.e.)*: 115-116. Kishyniev.

Kloczko W.I., Manichev V.I., Kompanec G.S., Kovalchuk M.S.

- 2003 Wychodnie rud miedzi na terenie Ukrainy zachodniej jako baza surowcowa metalurgii kolorowej w okresie funkcjonowania kultury trypolskiej. *Folia Praehistorica Posnaniensia* X/XI: 47-78.

Klochko V.I., Manichev V.I., Kvasnisa V.N., Kozak S.A. Demchenko L.V., Sokhatskiy M.P.

- 2000 Issues concerning Tripolye metallurgy and the Virgin copper of Volhynia. In: A.Koško (Ed.) *The Western Border Area of the Tripolye Culture. Baltic-Pontic Studies* 9: 168-186.

Klochko V.I., Tkachuk T.M.

- 1999 Skarb doby rannoi bronzы z s. *Pidhirtsi ta pytannia pokhodzhennia sokyr typu „Stublo”*. In: *Arkheolohichni vidkryttia v Ukraini 1998-1999*: 94-95. Kyiv.

Kłoczko W.I., Koško A., Razumow S., Włodarczak P.

- 2014 Problem dniestrzańsko – wiślańskiego szlaku w bałtyckich intruzjach społeczności kultur jamowej i katakumbowej. Zarys aktualnego stanu badań. In: A. Koško, M. Potupczyk, S. Razumow (Eds) *Naddniestrzańskie kompleksy cmentarzysk kurhanowych społeczności z III i z pierwszej połowy II tysiąclecia BC w okolicach Jampola, obwód winnicki. Z badań nad północno – zachodnią rubieżą osadnictwa społeczności kręgu kultur wczesnobrązowych strefy pontyjskiej (badania z lat 1984-2010)*, *Archeologia Bimaris, Monografie* 6, Poznań. (in print)

Kłosińska E.

- 1997 *Starszy okres epoki brązu w dorzeczu Warty*. Wrocław.

Kolosovskiy Y.V.

- 2000 *Arkheologicheskie issledovaniya v 2000 godu* (held in the archives of II NANB).
- 2001 *Otchet ob arkheologicheskikh issledovaniyakh v 2001 godu* (held in the archives of II NANB, nr. 1926).
- 2002 *Otchet ob arkheologicheskikh issledovaniyakh na gorodische Kimborovka v 2002 godu* (held in the archives of II NANB, nr. 2049).

Kopytsin V.F.

- 2004 *Arkheologicheskie pamiatniki Glusskogo rayona Mogilevskoy oblasti. Mogilev.*

Korenevsky S.N.

- 1974 O metallicheskih toporakh maykopskoi kultury. *Sovetskaya arkheologiya* 4: 16-31.
- 1976 O metallicheskih toporakh Severnogo Prichernomia i Nizhnego Povolzhia epokhi sredney bronzы. *Sovetskaya Arkheologiya* 4: 16-31.
- 1981 Vtulchatye topory – oruzhie blizhnego boya epokhi sredney bronzы Severnogo Kavkaza. In: B.A. Litvinskiy (Ed.) *Kavkaz i Sredniaya Aziya v drevnosti i srednevekovie*, 20-41. Moskva.

Korpusova V.N., Liashko S.N.

- 1990 Katakombnoe pogrebeniye s pshenitsey v Krimu. *Sovetskaya arkheologiya* 3: 166-175.

Koschik H.

- 1981 Die Bronzezeit im Südwestlichen Oberbayern. In: *Materialhefte zur Bayerischen Vorgeschichte. Reihe A. 50. Kallmünz.*

Kostrzewski J.

- 1928 Groby eneolityczne ze szkieletami skurczonymi w Białym Potoku (w pow. Czortkowskim). *Przegląd Archeologiczny* 3: 9-18.
- 1928a Przyczynki do epoki bronzowej na Wołyniu. *Przegląd Archeologiczny* 3: 111-115.
- 1938-1948 *Od mezolity do okresu wędrówek ludów*. In: Encyklopedia Polska. T. IV. *Kraków.*
- 1964 Skarby i luźne znaleziska metalowe od eneolitu do wczesnego okresu żelaza z górnego i środkowego dorzecza Wisły i górnego dorzecza Watry. *Przegląd Archeologiczny* 15: 3-78.

Kośko A.

- 1991 The Vistula-Oder Basins and North Pontic Region. *The Journal of Indo-European Studies* 19(3-4): 235-257.
- 2002 Fluted Maces in Cultural Systems of the Borderland of Eastern and We-



stern Europe: 2350 – 800 BC. Taxonomy, Genesis, Function. In: A.Koško (Ed.) *Fluted Maces in the System of Long-Distance Exchange Trails of the Bronze Age: 2350 – 800 BC. Baltic-Pontic Studies* 11: 31-81.

- 2011 Z badań nad kontekstem kultur wczesnobrązowych strefy pontyjskiej w rozwoju społeczności środkowoeuropejskich obszaru dorzecza Wisły w III tys. przed Chr. In: U. Stankiewicz, A. Wawrusiewicz (Eds) *Na rubieży kultur. Badania nad okresem neolitu i wczesnego brązu w Polsce Północno - Wschodniej*, 183-195. Białystok.

Koško A., Klochko V.I.

- 2009 Transit Routes between the Baltic and Black Seas: Early Development Stages – from the 3rd to the Middle of the 1st Millennium BC. An Outline of Research Project. In: A.Koško, V.Klochko (Ed.) *Routes between the Seas: Baltic-Bug-Boh-Pont from the 3rd to the Middle of the 1st Millennium BC. Baltic – Pontic Studies* 14: 9-18.

Koško A., Klochko V.I., Olszewski A.

- 2012 Ritualniy obiekt naselennia prichornomorskoyi kulturnoyi spilnoty doby rannoyi bronzы na r. San. *Arkheologia* 2: 67-75.

Koško A., Potupczyk M., Razumow S. (Eds)

- 2014 *Naddniestrzańskie kompleksy cmentarzysk kurhanowych społeczności z III i z pierwszej połowy II tysiąclecia BC w okolicach Jampola, obwód winnicki. Z badań nad północno – zachodnią rubieżą osadnictwa społeczności kręgu kultur wczesnobrązowych strefy pontyjskiej (badania z lat 1984-2010), Archeologia Bimaris, Monografie 6. Poznań. (in print)*

Kovaleva I.F.

- 1979 Vytianutye pogrebeniya Dneprovskogo areala Volgo-Dneprovskoy kulturno-istoricheskoy obschnosti epokhi eneolita. In: I.F. Kovaleva (Ed.) *Kurgannye drevnosti stepnogo Podneprovia III – I tys. do n.e.* vol. 3, 61-79. Dnepropetrovsk.
- 1983 *Pogrebalnyi obriad i ideologiya rannikh skotovodov. (Po materialam bronzovogo veka Levoberezhnoy Ukrainy)*. Dnepropetrovsk.
- 1995 Metallicheskie topory postmariupolskoy kultury. In: *Problemy arkheologii, drevney i srednevekovoі istorii Ukrainy. Tezisy dokladov nauchnoi konferentsii*, 28-30. Kharkov.

Kovalova I.F., Volkoboy S.S.

- 1976 Mayivskiyi lokalnyi variant zrubnoi kultury. *Arkheologia* 20: 3-22.

Kovaleva I.F., Volkoboy S.S., Larina Z.P.

- 1977 Issledovaniya kurgannykh mogilnikov u s. Verkhniaya Mayevka v stepnom mezhdurechie rek Oreli i Samary. In: *Kurgannye drevnosti stepnogo Podneprov'ia III – I tys. do n.e.*, 8-113. Dnepropetrovsk.

Krainov D.A.

- 1972 *Drevneyshaya istoriya Volgo-Okskogo mezhdurechia. Fatianovskaya kultura. II tysiacheletie do n.e.* Moskva.
- 1987 Fatianovskaya kultura. In: O.N. Bader, D.A. Krainov, M.F. Kosarev (Eds) *Epokha bronzy lesnoy polosy SSSR*, 58-76. Moskva.

Krauss R.

- 1977 Poglądy na kształtowanie się kultury lużyckiej w południowo-wschodniej Polsce. *Materiały Archeologiczne* 17: 5-51.

Krivtsova-Grakova O.A.

- 1955 Stepnoye Povol'ye i Prichernomor'ye v epokhu pozdney bronzy. In: *Materialy I issledovaniya po archeologii SSSR* 46. Moskva.

Krushelnytska L.I.

- 1985 *Vzaemov'iazky nasele'nnia Prykarpattia i Volyni z plemenami skhidnoyi i tsentralnoyi Evropy.* Kyiv.
- 1999 Etnokulturnyi rozvytok nasele'nnia skhidnokarpatskoho rehionu v dobu serednioyi i piznioyi bronzy. In: *Etnogenez ta etnichna istoriya nasele'nnia ukrainskykh Karpat*, 124-144, Lviv.

Kruts S.I.

- 1977 *Nasele'niye Stepnoy Ukrainy v epokhu eneolita-bronzy (po antropologicheskim dannym). Avtoreferat dissertatsii na soiskaniye uchonoj stepeni kandidata istoricheskikh nauk.* Kyiv.
- 1984 *Paleoantropologicheskie issledovaniya Stepnogo Podneprov'ia (epokha bronzy).* Kyiv.

Kruts S.I., Kubyšev A.I., Otroščenko V.V., Pustovalov S.Ž.

- 1991 Das menschliche Gesicht der Bronzezeit. In: R.Rolle, M. Müller-Wille, K. Schietzel (Eds) *Gold der Steppe. Archäologie der Ukraine*, 51-53. Schleswig.
- 1997 Antropologichnyi sklad nasele'nnia. In: P. Tolochko (Ed.) *Davn'ia istoriya Ukrainy*. vol.1, 374-383. Kyiv.

Kryvaltsevich M.M. (=Krivaltsevich N.N.)

- 1999 *Aziarnoe I – paselishcha epokhi bronzy na pounachy Palessya.* Minsk.
- 2001 Supolnastsi Belaruskaga Palessya i lesastepau-stepau u epokhu bronzy: problemy kulturnykh suviaz'iaiu. In: J. Czebreszuk, M. Kryvaltsevič,

- P. Makarowicz (Eds) *Od neolityzacji do początków epoki brązu: przemiany kulturowe w międzyrzeczu Odry i Dniepru między VI i II tys. przed Chr.*, *Archeologia Bimaris. Dyskusje* 2, 315-326. Poznań.
- 2004 Belaruskaie Palessie u peryad perahodu ad nealitu da epokhi bronzы: pablemy i perspektyvy arkhealogichnaga vyvuchennya. In: A. Koško (Ed.) *Wspólnota dziedzictwa kulturowego ziem Białorusi i Polski*, 137-162. Warszawa.
- 2005 Mnogovalikovaya keramika na territorii Belarusi. In: V.V. Otroshenko (Ed.) *Na poshanu Sofii Stanislavivni Berezanskoyi. Zbirka naukovykh prats*, 149-156. Kyiv.
- 2006 *Mogilnik siaredziny III– pachatku II tysiachagoddziau da n.e. na Verkhnim Dniapry – Prorva I*. Minsk.
- 2007 *Prorva I. Cmentarzysko z połowy III – początku II tysiąclecia przed Chr. na górnym Naddnieprzu*, *Archeologia Bimaris. Monografia* 2. Poznań
- 2010 Staryya Yurkovichy 1 – kulturna-khranalagichnyya aspekty “shnuravoga” kompleksu. *Materiyaly pa arkheologii Belarusi* 18: 217-242.
- 2011a Novyya vyniki dasledavannia pozniaga nealitu – pachatku epokhi bronzы u Zakhodnim Palessi. In: U. Stankiewicz, A. Wawrusiewicz (Eds) *Na rubieży kultur: Badania nad okresem neolitu i wczesną epoką brązu*, 207-217. Białystok.
- 2011b Pakhavanni siaredziny III – pachatku II tysiachagoddziau da n.e. na terytoryi Verkhniaga Padniaprouya: nekatoryyya vyniki strukturnykh dasledavanniau. In: H. Kowalewska-Marszałek, P. Włodarczak (Ed.) *Kurhany i obrządek pogrzebowy w IV-II tysiącleciu p. n. e.*, 293-308. Kraków, Warszawa.
- Kryvaltsevich M., Kaletshyts A.G.
- 2006 Z dasledavanyav „Tshintsa“ v Zachodnim Pelessi Belarusi, In: H. Taras (Ed.) *Zmierzch kompleksu trzciniacko-komarowskiego. Kształtowanie się nowej rzeczywistości kulturowej w środkowej i młodszej epoce brązu*, 41-81. Lublin.
- Krzak Z.
- 1961 *Materiały do znajomości kultury złockiej*. Wrocław.
- Kubyshev A.I., Nechytailo A.L.
- 1991 Tsenry metalloobrabatyvayushego proizvodstva azowo–chernomorskoy zony (k postanovke problemy). In: Bratchenko S.N., O.G. Shaposhnikova (Eds) *Katakombnye kultury Severnogo Prichernomia*, 6-21. Kyiv
- Kushnareva K.K., Chubinishvili G.N.
- 1970 *Drevneyshie kultury Yuzhnogo Kavkaza (V-III tys. do n.e.)*. Leningrad.

Kushtan D.P.

- 2001 Pamiatky z keramikoyu malopolovetskoho typu na Cherkaschyni. In: *Et-nokulturni protsesy u Serednomy Podniprovyi za materialamy arkheolohichnykh doslidzhen. Materialy naukovoyi konferentsii, Fastiv, hruden 2001*, 14-16. Kyiv.
- 2013 Pivden Lisostepovoho Podniprovya za doby piznioi bronzы. *Arheolohichniy almanakh 29*. Donetsk.

Kushtan D.P., Lysenko S.D.

- 2005 Steatytovi kukhli doby piznioi bronzы is Serednoho Podniprovya. In: *Kamiana doba Ukrainy 7. Do 85-richhya D.Ya. Telehina*, 226-231. Kyiv.

Lahodovska O.F.

- 1948 Voytsekhivskiy mohylnyk bronzovoi doby na Volyni. *Arheolohiya 2*: 62-77.

Lahodovska O.F., Zakharuk Yu.M.

- 1956 Novi doslidzhennia Voytsekhivskoho mohylnyka. In: *Arkheolohichni pamiatky Ukrainskoyi RSR, vol. 6*, 69-74. Kyiv.

Lakiza V.L.

- 2008 *Starozhytnastsy pozniaga nealitu i ranniaga periyiadu bronzavaga veku Belaruskaga Poniamonnia*. Minsk.

Latynin B.A.

- 1964 K voprosu o pamiatnikakh s tak nazyvaemoy mnogovalikovoy keramikoy. *Arkheologicheskiy sbornik Gosudarstvennogo Ermitazha 6*: 53-71.

Lewandowski S.

- 1978 Cmentarzysko z epoki brązu i wczesnej epoki żelaza w Paluchach, woj. Przemysł. *Sprawozdania Archeologiczne 30*: 129-150.

Libera J.

- 2001 *Krzemienne formy bifacjalne na terenach Polski i Zachodniej Ukrainy (od środkowego neolitu do wczesnej epoki żelaza)*. Lublin.

Libera J., Zakościelna A.

- 2011 Cyrkulacja krzemienia wołyńskiego w okresie neolitu w we wczesnej epoce brązu na ziemiach polskich. In: M. Ignaczak, A. Koško, M. Szmyt (Eds) *Między Bałtykiem a Morzem Czarnym. Szlaki międzymorza IV – I tys. przed Chr. Archeologia Bimaris. Dyskusje 4*: 83-115, Poznań.

Likhachov V.A.

- 1981 Ob odnom tipe sosudov katakombnogo vremeni. In: I.F. Kovaleva (Ed.) *Stepnoe Podneprovie v bronzovom i rannem zeleznom vekakh*,: 72-76. Dnepropetrovsk.

Lißner B.

- 2004 Zu den frühbronzezeitlichen Gruppen in Süddeutschland. In: *Beiträge Ur- und Frühgeschichtlichen Archäologie* 13: 1-20.

Litvinova L.V.

- 2001 Naseleniye Srednego Podneprovia v epokhu pozdney bronzy (po materialam mogilnika Malopolovetskoe-3). In: *Etnokulturni protsesy u Seredno-my Podniprovyi za materialamy arkheolohichnykh doslidzhen. Materialy naukovoyi konferentsii, Fastiv, hruden 2001*, 10-12. Kyiv.

Lotman Ju.M.

- 1992 O semiosfere. In: *Izbrannye statyi v 3 t., vol.1*, 11-25. Tallinn.

Lutteropp K.

- 2009 *Untersuchungen zu weiblichen und männlichen Bestattungen der Frühen Bronzezeit: Bestattungsgemeinschaften mit bipolar geschlechtsdifferenzierten Bestattungssitten und ihre Sozialstrukturen im Raum Niederösterreich (Inaugural-Dissertation zur Erlangung der Doktorwürde der Philosophischen Fakultät der Rheinischen Friedrich-Wilhelms-Universität)*. Bonn.

Lysenko S.D.

- 1998 Rezultaty issledovania mogilnika Malopolovetskoe-3 na Kyivshchine v 1993-1997 godakh. In: A.Koško, J. Czebreszuk (Eds) „Trzciniac”: system kulturowy czy interkulturowy proces?, *Archeologia Bimaris. Dyskusje* 1, 95-117. Poznań.
- 1998a K voprosu o pamiatnikakh s keramikoy malopolovetskogo tipa. In: *Problemy izucheniya katakombnoy kulturo-istoricheskoy obschnosti (KKIO) i kulturo-istoricheskoy obschnosti mnogovalikovoy keramiki (KIOMK)*, 91-97. Zaporozhe.
- 1999 Kozarovytskyi mohylnyk doby piznoyi bronzy. *Vita Antiqua* 2: 73-79.
- 2006 Kubki maevskogo tipa iz Srednego Podneprovia. In: *Arkheologicheskoe izucheniye Tsentralnoy Rossii. Tezisy mezhdunarodnoy nauchnoy konferentsii, posviaschennoy 100-letiyu so dnia rozhdeniya V.P. Levkina*: 181-183. Lipetsk.
- 2007 Dinamika razvitiya tshinetskogo kulturnogo kruga na granitse pravoberezhnoy lesostepi i Polesia. In: M. Gierlach, L. Bakalarska (Eds) *Wspólnota dziedzictwa archeologicznego ziem Ukrainy i Polski. Materiały z konferencji. Łańcut* (26- 28 X 2005 r.), 341-389. Warszawa.
- 2011 K voprosu o kulturno-khronologicheskoy i fuktionalnoy prinadlezhnosti kostianykh „priazhek” v Srednem Podneprove. *Kratkie soobscheniya Instituta arkheologii* 225: 123-143.

- 2012 Pamiatniki epokhi bronzy – rannego zheleznoho veka u s. Voloshkovo (po materialam issledovaniy 2009-2011 gg.). In: *Problemy doslidzhennia pamiatok arkheolohii Skhidnoi Ukrainy. Materialy III Luhanskoyi mizhnarodnoi historyko-arkheolohichnoi konferentsii, prysviachenoi pamiaty S.N. Bratchenka*, 278-283. Kyiv.
- 2013 K voprosu o vozmozhnykh kontaktakh kievo-cherkasskoy grupy tshinet-skogo kulturnogo kruga s Donetskimi GMTs. In: Yu.M. Brovender (Ed.) *Problemy hirnychoi arkheolohii (Materialy IX mizhnarodnoho Kartamy-skoho poliovoho arkheolohichnoho seminaru)*, 86-96. Alchevsk.

Lysenko S.D., Gaskevich D.L.

- 1999 Pamiatniki s keramikoy malopolovetskogo tipa basseyna r. *Trubezh*. In: *Arkheolohichni vidkryttia v Ukraini 1998-1999 rr.*, 113-115. Kyiv.

Lysenko S.D., Kushtan D.P.

- 1997 Pro vydilennia pamiatok z keramikoyu malopolovetskoho typu. In: *V Mizhnarodna arkheolohichna konferentsia studentiv ta molodykh vchenykh (kviten 1997 r.)*, 109-112. Kyiv.
- 2005 Steatitovye kruzhki epokhi pozdney bronzy iz Srednego Podneprov'ia. In: *Arkheomineralogiya i rannia istoria mineralogii (Materilay mezhdunarodnogo seminaria)*, 51-54. Syktyvkar.

Lysenko S.D., Kushtan D.P., Pankovskiy V.B., Fedko V.F.

- 2011 Pamiatniki malopolovetskogo tipa v basseyne r. *Supoy*. In: *Drevnosti. Kharkovskiy istoriko-arkheologicheskyy yezhegodnik*, 228-241. Kharkov.

Lysenko S.D., Lysenko S.S.

- 2002 Issledovaniya na mogilnike Malopolovetskoe-3 v 2001 g. In: *Arkheolohichni vidkryttia v Ukraini 2000-2001 pp.*, 168-177. Kyiv.
- 2003 Issledovaniya na mogilnike Malopolovetskoe-3 v 2002 g. In: *Arkheolohichni vidkryttia v Ukraini 2001-2002 pp.*, 168-179. Kyiv.
- 2004 Issledovaniya na mogilnike Malopolovetskoe-3 v 2003 g. In: *Arkheolohichni vidkryttia v Ukraini 2002-2003 pp.*, 198-210. Kyiv.
- 2009 Ground Communications of the Eastern Area of the Trzciniec Culture Circle. In: A. Koško, V. Klochko (Eds) *Routes between the Seas: Baltic – Boh – Bug – Pont from the 3rd to the Middle of the 1st Millennium BC. Baltic-Pontic Studies* 14: 338-367. Poznań.
- 2012 Voytsekhovskiy mogilnik v svete novykh issledovaniy. In: *Kultury stepnoy Evrazii i ikh vzaimodeystvie s drevnimi tsivilizatsiyami. Materialy mezhdunarodnoy nauchnoy konferentsii, posviashchennoy 110-letiyu so dnia rozhdeniya vydayushchegosia rossiyskogo arkheologa Mikhaila Petrovicha Griaznova*, vol.2, 90-95. Sankt Petersburg.



- 2013 Novye issledovaniya Voytsekhivskogo mogilnika. In: *Tsivilizatsionnye tsenry i pervobytnaya periferiya v epokhu rannego metalla: modeli vzaimodeystviya. Tezisy dokladov kruglogo stola, posviaschennogo pamiaty N.Ya. Merperta*, 24-25. Moskva.
- Lysenko S.D., Pankovskiy V.B., Kushtan D.P., Fedko V.F.  
 2011 Pamiatniki rubezha sredney-pozdney bronzy u s. Bespalche na Supoe. *Donetskiy arkeolohichnyi zbirnyk* 15: 133-147.
- Lysenko S.D., Skiba A.V.  
 1998 Pamiatniki s keramikoy malopolovetskogo tipa na Supoe In: *Arkheolohichni vidkryttia v Ukraini 1997-1998* pp., 106-109. Kyiv.
- Lysenko S.S.  
 2006 *Prykrasy naseleння Ukrainy doby piznioi bronzy. Avtoreferat na zdobuttia stupenia kandydata istorychnykh nauk*. Kyiv.
- Lytvynenko R.O. = Litvinenko R.A.  
 2001 Kultura Babyno (mnogovalikovoy keramiki) i ee mesto v sisteme bronzo-vogo veka yuga Vostochnoy Evropy. In: *Bronzovyi vek Vostochnoy Evropy: kharakteristika kultur, khronologia i periodyzatsia*, 161-169. Samara.  
 2006 Opyt vyivlenia prostranstvenno-semanticheskikh struktur v pogrebalnom obriade kultury Babyno. *Strukturno-semioticheskie issledovania v arkeologii* 3: 215-236.  
 2006a Dnepro-donskaya babinskaya kultura (istochniki, areal, pogrebalnyi obriad). *Materialy ta doslidzhennia z arkeolohii Skhidnoyi Ukrainy* 5: 157-187.  
 2007 Obstavyny i chynnyky babynskoi kulturogenezy. *Visnyk Donetskoho universytetu. (Seriya B: Humanitarni nauky)* 1-2: 109-116.  
 2008 Pamiatky typu Babyne III: vid kultury do kulturnoho kola. *Novi storinky istoriyi Donbasu* 15/16: 342-354.  
 2008a Do otsinky peryferiynykh grup Babyne polisko-lisostepovoi Naddnyprianschyny. *Visnyk Donetskoho universytetu (Seriya B: Humanitarni nauky)* 2: 180-190.  
 2009 Geneza, rozvytok ta istorychna dolia kulturnoho kola Babyne. *Materialy ta doslidzhennia z arkeolohii Skhidnoyi Ukrainy* 9: 44-90.  
 2009a *Kulturne kolo Babyne (za materialamy pokhvalnykh pamiatok). Avtoreferat na zdobuttia stupenia doktora istorychnykh nauk*. Kyiv.  
 2011 Babynska kultura na perekhresti Kavkazskoho i Karpatsko-Dunayskoho impulsiv kulturogenezy. In: *Materialy naukovoi konferentsii profesorsko-vykladatskoho skladu, naukovykh spivrobitnykiv i aspirantiv DNU za pidsumkamy naukovo-doslidnoyi roboty za period 2009-2010 rr.*, 249-250. Donetsk.

- 2011a Kulturne kolo Babyno: dosvid kulturohenetychnykh doslidzhen v arkheolohii. *Istorychni ta politolohichni doslidzhennia* 1-2 (47-48): 169-178.
- 2011b Kulturnyi krug Babyno: nazvaniye, taksonomiya, struktura. *Kratkie soobshcheniya Instituta Arkheologii* 225: 108-122.
- 2011c Obriad vtorynnoho pokhovannia v kulturach babynskoho kola. *Donetskyi arkheolohichniy zbirnyk* 15: 7-35.
- 2012 Kavkaz i Nadchornomoria: liniiy synkhronizatsii dlia finalu serednioi bronzy. *Hileya* 61 (6): 104-108.

Łęczycki S.

- 2004 Kietrz, Bytyń, Szczecin-Śmierdnica. Einige Anmerkungen zur Kulturzugehörigkeit des Hortfundes von Bytyń. *Sprawozdania Archeologiczne* 56: 33-59.

Łysenko S.D. Szmyt M.

- 2011 Środkowe Naddnieprze jako graniczny areał osadnictwa ludności kultury amfor kulistych. In: Ignaczak M., Koško A., Szmyt M. (Eds) *Między Baltykiem a Morzem Czarnym. Szlaki międzymorza IV – I tys. przed Chr. Archeologia Bimaris. Dyskusje* 4: 239-246. Poznań.

Machnik J.

- 1958 Z badań nad wczesną epoką brązu na Ukrainie. *Sprawozdania Oddziału PAN w Krakowie* 3: 92-96.
- 1960 Zabytki z kurhanów kultury ceramiki sznurowej w Wiktorowie (USSR). *Materiały archeologiczne* 2: 69-72.
- 1961 Problem osad kultury ceramiki sznurowej w dorzeczu górnego Sanu i Dniestru. *Acta Archaeologica Carpathica* 3: 209-218.
- 1972 Die Mierzanowice-Košfany-Kultur und das Karpatenbecken. *Slovenská archeológia* 20: 177-188.
- 1967 Stosunki kulturowe na przełomie neolitu i epoki brązu w Małopolsce (na tle przemian w Europie środkowej). *Materialy do prahistorii ziem polskich III. Warszawa*.
- 1977 *Frühbronzezeit Polens (Übersicht über die Kulturen und Kulturguppen)*. Wrocław-Warszawa-Kraków-Gdańsk.
- 1978 Wczesna epoka brązu. In: J. Machnik, B. Gediga, J. Miśkiewicz, W. Hensel (Eds) *Prahistoria ziem Polskich, vol. 3*, 1-212. Wrocław.
- 1979 Ze studiów nad kulturą ceramiki sznurowej w dorzeczu górnego Dniestru. *Acta Archaeologica Carpathica* 19: 50-71.
- 1982 Uwagi o wyrobach metalowych z początków epoki brązu w południowo-wschodniej Polsce. *Pamiętnik Muzeum Miedzi* 1: 79-100.
- 1987 *Kultury z przełomu eneolitu i epoki brązu w strefie karpackiej*. Wrocław.
- 1991 *The Earliest Bronze Age in the Carpathian Basin*. Bradford.

- 1999 *Radiocarbon chronology of the Corded Ware culture on Grzęda Sokolska. A middle Dnieper traits perspectives.* In: A. Koško (Ed.) *The Foundations of Radiocarbon Chronology of Cultures between the Vistula and Dnieper: 3150-1850 BC.* *Baltic-Pontic Studies* 7: 221-250.
- 2009 Short and long-distance pastoral journeys along ancient upland routes in Europe in the 3rd Millenium BC. In: A. Koško, V. Klochko (Ed.) *Routes between the Seas: Baltic-Bug-Boh-Pont from the 3rd to the Middle of the 1st Millennium BC.* *Baltic-Pontic Studies* 14: 214-222.
- Machnik J., Bagińska J., Koman W.  
 2009 *Neolityczne kurhany na Grzędzie Sokalskiej w świetle badań archeologicznych w latach 1988 – 2006.* Kraków.
- Machnik J., Gediga B., Miśkiewicz J., Hensel W.  
 1978 *Prahistoria ziem polskich vol. 3.* Wrocław-Warszawa-Kraków-Gdańsk.
- Makarowicz P.  
 1999 The Problem of Reception of Otomani Culture Patterns on the Polish Lowlands. In: J. Gancarski (Ed.) *Kultura Otomani-Füzesabony – rozwój, chronologia, gospodarka,* 231-247. Krosno.  
 2003 The Construction of Social Structure: Bell Beakers and Trzciniec Complex in North-Eastern Part of Central Europe. *Przegląd Archeologiczny* 51: 123-158.  
 2008 Elitarne pochówki z kurhanu komarowskiego w Ivanju na Wołyniu – zarys możliwości interpretacyjnych. In: J. Bednarczyk, J. Czebreszuk, P. Makarowicz, M. Szmyt (Eds) *Na pograniczu światów. Studia z pradziejów międzymorza bałtycko-pontyjskiego ofiarowane Profesorowi Aleksandrowi Koško w 60. rocznicę urodzin,* 333-352. Poznań.  
 2009 Baltic-Pontic Inter Regional Routes at the Start of the Bronze Age. In: A. Koško, V.I. Klochko (Eds) *Routes between the Seas: Baltic-Bug-Boh-Pont from the 3rd to the Middle of the 1st Millennium BC,* *Baltic-Pontic Studies* 14: 301-336.  
 2010 *Trzciniecki krąg kulturowy – wspólnota pogranicza Wschodu i Zachodu Europy.* Poznań.  
 2012 Zwischen baltischem Bernstein und transylvanischem Gold. Der Trzciniec-Kulturkreis – nordöstlicher Partner der Otomani/Füzesabony-Kultur, In: M. Jaeger, J. Czebreszuk, K.P. Fischl (Eds) *Enclosed Space – Open Society. Contact and Exchange in the Context of Bronze Age Fortified Settlements in Central Europe. StudienzurArchäologie in Ostmitteleuropa/Studia nad Pradziejami Europy Środkowej* 10. Poznań–Bonn 2012, 179-216.

Makarowicz P., Gorbacz-Klempka A.

- 2014 Osada metalurgów w Szczepidle nad środkową Wartą. Z badań nad wytwórczością z brązu w II tys. BC. *Fontes Praehistorici Posnanienses* 50 (in print).

Makarowicz P., Lysenko S., Kočkin I.

- 2013 Wyniki badań cmentarzyska kultury komarowskiej w Bukivnej nad górnym Dniestrem w 2010 roku. *Materiały Archeologiczne* 29: 101-120.

Manzura I.V., Klochko E.O, Savva E.N.

- 1992 *Kamenskie kurgany*. Kishiniev.

Markus I., Okhrimenko H.

- 2010 *Ozbroyennia ta znariaddia pratsi naselelnia Zakhidnoi Volyni IV – II tys. do R.Ch.* Lutsk.

Marková K.

- 1998 Kultúrny vývin v závere staršej doby bronzovej na juhu stredného Slovenska a možnosti kultúrnych vzťahov s južným Poľskom. In: A. Koško, J. Czebreszuk (Eds) „*Trzciniac*” – *system kulturowy czy interkulturowy proces?*, 253-258. Poznań.

- 2003 Austauschentwicklung im Karpatenbecken im Lichte der Bernstainfunde (vorläufige Anmerkungen). In: C. Kacsó (Ed.) *Bronzezeitliche Kulturercheinungen im Karpatischen raum. Ehrensposium für Alexandru Vulpe zum 70. Geburtstag. Baia Mare 10.-13. Oktober 2001.*, 339-352. Baia Mare.

Martirosian A.A.

- 1964 *Armeniya v epokhu bronzy i rannego zheleza*. Erevan.

Marzatico F., Tecchiati U.

- 2001 The Bronze Age in Trentino and Alto Adige/SüdTirol. *Preistoria Alpina* 34: 27-60.

Matthias W.

- 1969 Die Schnurkeramik im westlichen Mitteldeutschland. In: H. Behrens, F. Schlette (Eds) *Die neolithischen Becherkulturen im Gebiet der DDR und ihre europäischen Beziehungen, Veröffentlichungen des Landesmuseums für Vorgeschichte in Halle* 24, 9-29. Berlin.

- 1982 Kataloge zur mitteldeutschen Schnurkeramik. Teil V. Mittleres Saalegebiet. In: *Veröffentlichungen des Landesmuseums für Vorgeschichte in Halle* 35. Berlin.

Matuschik I.

- 1996 Brillen- und Hakenspiralen der frühen Metallzeit Europas. *Germania* 74 (1): 1-43.

Melis E.

- 2013 Data on Early Bronze Age apparel on the basis of a cremation grave excavated at Ménfőcsanak-Széles-Földek. *Hungarian archaeology, autumn 2013*: [http://www.hungarianarchaeology.hu/wp-content/uploads/2013/10/eng\\_Melis\\_130.pdf](http://www.hungarianarchaeology.hu/wp-content/uploads/2013/10/eng_Melis_130.pdf)

Melnik V.I.

- 2012 Problemy urovney obshchnosti katakombnogo kulturnogo kruga. *Kratkie soobscheniya Instituta arkheologii* 225: 10-15.

Melnikovskaya O.N.

- 1967 *Plemena Yuzhnoy Belorussii v rannem zheleznom veke*. Moskva.

Melnyk O.O., Balabanov S.V.

- 2007 *Istorichna entsyklopediya Kryvorizhzhia, vol.1*. Kryvyi Rih.

Melnyk O., Steblina I.

- 2012 *Kurhany Kryvorizhzhia*. Kryvyi Rih.

Merpert N.Ya.

- 1974 *Drevneishie skotovody Volgo-Uralskogo mezhdurechia*. Moskva.  
1982 Eneolit yuga SSSR i evraziiskie stepi. In: V.M. Masson, N.Ya Merpert (Eds) *Eneolit SSSR. Arkheologia SSSR*: 321-331. Moskva.

Motzoi-Chicideanu I.

- 1995 Fremdgüter im Monteoru-Kulturraum. In: B. Hänsel (Ed.) *Handel, Tausch und Verkehr im bronze- und früheisenzeitlichen Südosteuropa; Prähistorische Archäologie in Südosteuropa* vol. 11, 219-242. München – Berlin.

Movsha T.G.

- 1957 Mednye ukrasheniya iz Kyiva. *Kratkie Soobschenia Instituta Istorii Materialnoi Kultury* 70: 96-99.

Munchayev R.M.

- 1975 *Kavkaz na zare bronzovogo veka*. Moskva.

Müller J. , Czebreszuk J.,Kneisel J. (Eds)

- 2010 *Bruszczewo II. Ausgrabungen Und Forschungen in einer prähistorischen Siedlungskammer Großpolens. Studien zur Archäologie in Ostmitteleuropa 6.1-6.2*. Bonn.

Müller-Karpe H.

1974 *Handbuch der Vorgeschichte*, vol. 3. München.

Munteanu R.

2010 Începutul bronzului mijlociu în depresiunile marginale ale Carpaților Orientali. *Bibliotheca Memoriae Antiquitatis* 24. Piatra-Neamț.

Muzolf P.

2012 Osadnictwo kultury trzcienieckiej. In: B. Muzolf (Ed.) *Lutomiersk–Koziówki, stanowisko 3a-c, pow. pabianicki, woj. łódzkie. Wielokulturowy zespół osadniczy od schyłkowego paleolitu po okres nowożytny*, 58-113. Biblioteka Muzeum Archeologicznego i Etnograficznego w Łodzi, Nr 39. Łódź.

Mymokhod R.A.

2010 Radiouglerodnaya khronologiya bloka postkatakombnykh kulturnykh obrazovaniy. In: *Materialy ta doslidzhennia z arkheolohiyi Skhidnoi Ukrainy* 10: 32-55. Luhansk.

2011 Radiouglerodnaya khronologia bloka postkatakombnykh kulturnykh obrazovaniy. In: *Kratkie soobschenia Instituta Arkheologii* 225: 28-53.

2013 Postkatakombnyi period v Nizhnem Povolzhie i Volgo-Donskom mezhdurehie: sodержanie i definitsii. *Arkheologiya vostochnoyevropeiskoi stepi* 10: 167-179.

Nagy M.

2013 Der Südlichste Fundort der Gáta Wieselburg Kultur in Zseny – Kavicsbánya/Schottergrube, Komitat Vas, Westungarn. *Savaria* 36: 75-143.

Nechytailo A.L.

1991 *Sviazi naseleniya Steпноy Ukrainy i Severnogo Kavkaza v epokhu bronzy*. Kyiv.

Neugebauer C., Neugebauer J.-W.

1997 Das frühbronzezeitliche Gräberfeld Franzhausen I. In: *Fundberichte aus Österreich. Materialhefte* 5, 1-1400.

Niculică B.

2004-2005 Considérations sur la période moyenne de l'âge du bronze dans le plateau de Suceava. Le complexe culturel Komarów – Costișa – Biały Potik. *Studia Antiqua et Archaeologica* 10-11: 61-68.

Niedźwiedz J., Taras H.

2006 Schyłek kultury trzcienieckiej i początki kultury łużyckiej we wschodniej Lubelszczyźnie. In: H. Taras (Ed.) *Zmierzch kompleksu trzcieniecko-ko-*



*marowskiego. Kształtowanie się nowej rzeczywistości kulturowej w środkowej i młodszej epoce brązu, 91-109. Lublin.*

Nikitenko I.S.

2011 Do pytania pro vydilennia kamnedobuvnoi hirnychoi provintsii doby bronzы u zoni rozpovsiudzhennia tsentralnykh ta skhidnykh blokiv Ukrainskoho schyta. In: *Problemy hirnychoi arkheolohii (Materialy VIII mizhnarodnoho Kartamyskoho polovoho seminaru)*, 80-88. Alchevsk.

Nikitenko N.N.

1977 O datirovke balkinskogo rala. In: V.D. Baran (Ed.) *Novye issledovaniya arheologicheskikh pamiatnikov na Ukraine*, 44-47. Kyiv.

Nikitin V.I.

1989 Matveevka 1 – poselenie katakombnoy kultury na Yuzhnom Buge. *Sovetskaya Arkheologiya* 2: 136-150.

Nikolova A.V.

1992 *Hronologicheskaya klassifikaciya pamyatnikov yamnoj kultury stepnoj zony Ukrainy: Avtoreferat disertacii na zdobuttia naukovoogo stupenju kandidata istorichnih nauk*. Kyiv.

2006 K voprosu o kulturnoy atributsii pogrebeniy ranney bronzы s ostatkami transportnykh sredstv v Severnom Prichernomorie. *Arheologicheskie pamiatniki Vostochny Evropy* 12: 79-86.

Nikolova A.V., Mamchych T.I.

1997 Do metodyky klasyfikatsiyi posudu yamnoyi kultury. *Arkheolohiya* 3: 101-115.

Nosek S.

1947 Zagadnienie Prasłowiańszczyzny w świetle prehistorii. *Światowit* 19: 1-177.

Okhrimenko G.V.

2012 Zakhidna Volyn-Pripyntida: etnokulturni kontakty. In: *Pratsi Naukovodoslidnoho Institutu pamiatkoohoronnikh doslidzhen vol. 7*, 258-262. Kyiv.

Ondrůček J., Šebela L.

1985 Pohřebiště nitranskůkupiny v Holešově (catalog nálezů). In: *Studie Muzea Kroměřížska*: 2-130. Kroměříž.

Ostojuhevo

1994 *Ostojuhevo nekropola bronzanog doba*. Belgrad.

Otroschenko V.V.

- 2001 *Problemy periodyzatsii kultur serednioi ta piznioi bronzy Skhidnoi Evropy (kulturo-stratyhrafichni zistavlennia)*. Kyiv.
- 2005 Epokha eneolitu – bronzy. In: L.L. Zalizniak (Ed.) *Arkheolohiya Ukrainy*, 105-202. Kyiv.
- 2011 Problemy vyvchennia pamiatok Babynskoyi spilnoty Serednioyi Naddnyprianschyny. *Pereyaslivka. Naukovi zapyski* 5 (7): 159-162.

Otroschenko V.V., Pustovalov S.Z.

- 1991 Obriad modelirowania litsa po cherepu u plemen katakombnoy obschnosti. In: *Dukhovnaya kultura drevnikh obshchestv na territorii Ukrainy*, 59-84. Kyiv.

Palahuta I.V.

- 1996 Kulturna nalezhnist pamiatok serednioi ta piznioi bronzy Cherkaskoho Livoberezhzhia. *Arkheolohiya* 1: 61-69.

Pankovskiy V.B.

- 2005 Do problemy kistianoi industrii tshynetskoho kulturnoho kola (Malopovolovetske-3). In: *Problemy arkheolohii Serednioho Podniprov'ia: Do 15-richchia zasnovannia Fastivskoho derzhavnogo kraeznavchoho muzeyu*, 120-142. Kyiv – Fastiv.
- 2010 Novye dannye o kostianoy industrii tshinetskogo kulturnogo kruga. In: *Arkheolohichni pamiatky Fastivschyny. Materialy ta doslidzhennia: Do 75-richchya N.M. Kravchenko. Pres-muzey* 26-27: 42-50. Fastiv.

Parker Pearson M.

- 1999 *The Archaeology of Dead and Burial*. Sutton.

Perini R.

- 1971 I depositi preistorici di Romagnano-Loc (Trento). *Preistoria Alpina* 7: 7-106.

Petrenko V.G.

- 2010 Kurgan epokhi paleometalla na poberezhie Khadzhibeiskogo limana. *Materialy po arkheologii Severnogo Prichernomoria* 11: 303-368.

Petrun V.F.

- 1967 Petrografiya i nekotorye problemy materiala kamennykh liteynykh form epokhi bronzy Severnogo Prichernomoria. In: *Pamiatniki epokhi bronzy yuga Evropeyskoy chasti SSSR*, 185-194. Kyiv.

Pobol L.D.

- 1964 *Otchet ob arkheologicheskikh issledovaniakh na territorii BSSR v 1964 godu* (held in the archives of II NANB, nr. 238).

- 1966 Pogrebenie epokhi bronzы bliz d. Borisovschina Mogiliovskoy obl. *Sovetskaya Arkheologiya* 2: 294-297.
- Popova T.B.  
1955 Plemena katakombnoy kultury. *Trudy Gosudarstvennogo istoricheskogo muzeya* 24. Moskva.
- Popovich S.  
2008 Issledovaniya kurgana u s. Orxej. *Revista Archaeologica. Serie nouă. IV* (1): 93-99.
- Priakhin A.D.  
1996 *Mosolovskoe poselenie metallurgov-liteyschikov epokhi pozdney bronzы: Kniga vtoraya*. Voronezh.
- Priakhin A.D., Savrasov A.S.  
1989 Gliniane litynye formy s Mosolovskogo poseleniya metallurgov-liteyschikov. In: A.D. Priakhin (Ed.) *Poseleniya srubnoy obschnosti*, 39-80. Voronezh.
- Przybyła M.S.  
2009 *Intercultural contacts in the Western Carpathian area at the turn of the 2nd and 1st millenia BC*. Warszawa.
- Przybyła M.S., Skoneczna M.  
2012 The fortified settlement from the Early and Middle Bronze Age at Maszkowice, Nowy Sącz District (Western Carpathians). In: *Preliminary results of studies conducted in the years 2009–2012. Recherches Archéologiques* 3: 5-66.
- Pustovalov S.Z.  
1994 Economy and Social organization of Northern Pontic Steppe-Forest-Steppe Pastoral Populations: 2750 – 2000 BC (Catacomb Culture). In: A.Koško (Ed.) *Nomadism and Pastoralism in the Circle of Baltic-Pontic Early Agrarian Cultures: 5000-1650 BC. Baltic-Pontic Studies* 2: 86-134.  
1995 Ob obschestvennom polozhenii masterov-remeslennikov v epokhu sredney bronzы. In: *Khoziaystvo drevnego naseleniya*, 211-221. Kyiv.  
1997 Rekonstruktsiya chyslenosti katakombnogo naselennia za kurhannymy pamiatkami Pivnichnoho Prychornomoria. *Arkheolohiya* 3:40-49.  
1998 K voprosu o yamno-katakombnoy epokhe. In: *Problemy arkheologii Yugo-Vostochnoy Evropy*, 63-64. Rostov-na-Donu.  
1999 Ingul'skaya katakombnaya kultura i kriterii vydeleniya arkheologicheskikh kultur. In: *Etnichna Istoriya ta kultura naselenniya Stepu ta Lisostepu Evrazii (vid kamianoho viku po ranne serednovichchia: Materialy mizhnarodnoi arkheolohichnoi konferentsii, 73-75*. Dnipropetrovsk.

2005 *Sotsialnyi lad katakombnoho suspilstva Pivnichnoho Prychornomoria*. Kyiv.

Rachwaniec A.

1985 Materiały archeologiczne ze starszego okresu epoki brązu oraz kultury lużyckiej z rejonu Kopca Wandy w Nowej Hucie-Mogile. *Materiały Archeologiczne Nowej Huty* 9: 89-191.

Rasovskiy D.A.

1993 Pechenegi, torki i berendei na Rusi i v Ugrii. In: *Sbornik statei po arkheologii i vizantinovedeniyu* 6: 82-142. Praga.

Rassamakin Y.Y.

1994 The Main Directions of the Development of Early Pastoral Societies of the Northern Pontic Zone: 4500 – 2450 BC (Pre-Yamnaya Cultures and Yamnaya Culture). In: A.Koško (Ed.) *Nomadism and Pastoralism in the Circle of Baltic-Pontic Early Agrarian Cultures: 5000-1650 BC*. *Baltic-Pontic Studies* 2: 29-70.

1999 The Eneolithic of the Black Sea Steppe: Dynamics of Cultural and Economic Development 4500-2300 BC. In: M.Levine, Y. Rassamakin, N. Kislenko, N. Tatarintseva (Eds) *Late Prehistoric Exploitation of the Eurasian Steppe*, 59-182. Cambridge.

Razumov S.M.

2010 *Kremiani vyroby naselennia Nadchornomoria doby rannioi ta serednioi bronzy (za materialamy pokhovan): Avtoreferat disertatsiyi na zdobuttia naukovooho stupenia kandydata Istorichnykh nauk*. Kyiv.

2011 *Flint Artefacts of Northern Pontic Populations of the Early and Middle Bronze Age: 3200-1600 BC*, *Baltic-Pontic Studies* 16

Razumov S.M., Koško A., Karnaukh Ye.H.

2011 Roboty spilnoi Ukraino-Polskoi Yampilskoi arkheolohichnoi ekspedytsii. In: *Arkheolohichni doslidzhennia v Ukraini v 2010 r.*, 286. Kyiv-Poltava.

Razumov S.N., Lysenko S.D., Koško A.

2012 Babinskoe pogrebeniye s chashey u s. Porogi na Dnestre. In: O.I. Hurzhiy et al. (Eds) *Arkasivski chytannia: materialy II Mizhnarodnoi naukovopraktychnoi konferentsii*, 84-87. Mykolaiv.

Rogozińska R.

1959 Cmentarzysko kultury komarowskiej w Bukównie. *Materiały Archeologiczne* 1: 97-114.

Romaniszyn J.

- 2013 *Obrzędowość pogrzebowa społeczności kultury komarowskiej w dorzeczu górnego Dniestru i Seretu (manuscript of PhD dissertation, Institute of Prehistory AMU in Poznań)*. Poznań.

Róska M.

- 1957 A fajszi típusú rézbalták. *Folia Archaeologica* 8: 43-46.

Ruckdeschel W.

- 1978 Die Frühbronzezeitlichen Gräber Südbayerns. *Ein Beitrag zur Kenntnis der Straubinger Kultur*. In: *Antiquitas* 11. Bonn.

Rychkov N.A.

- 1990 *Etnicheskaya kharakteristika naseleniya yamnoj kultury Severnogo Prichernomorya*. Avtoreferat dissertacii na soiskaniye uchenoj stepeni kandidata istoricheskikh nauk. Kiev.

Ryndina N.V., Konkova L.V.

- 1982 O proiskhozhdenii bolshikh usatovskikh kinzhalov. *Sovetskaya Arkheologiya* 2: 30-42.

Sandars N.K.

- 1961 The first Aegean swords and their ancestry. *American Journal of Archaeology* 65-1: 17-30.

Sangmeister E.

- 1974 Zwei Neufunde der Glockenbecherkultur in Baden-Württemberg. *Fundberichte aus Baden-Württemberg* 1: 103-137.

Sanzharov S.N.

- 2001 *Katakombnye kultury Severo-Vostochnogo Priazovia*. Lugansk.  
 2008 *Strelochnye nabory instrumentov i syria iz katakombnykh pogrebeniy Ukrainy*. Lugansk.  
 2010 *Vostochnaya Ukraina na rubezhe epokh sredney-pozdney bronzy*. Lugansk.

Savva E.N.

- 1992 *Kultura mnogovalikovoy keramiki Pruto-Dnestrovskogo mezhdurechia*. Kishinev.  
 1998 Die Rolle der "östlichen" und "westlichen" Elemente bei der Genese des Kulturkomplexes Noua-Sabatinovka. W: B. Hänsel, J. Machnik (Eds) *Das Karpatenbecken und die Osteuropäische Steppe. Nomadenbewegungen und Kulturaustausch in den vorchristlichen Metallzeiten (4000-500 v. Chr.)*, München-Rahden/Westf., 267-312.

Schaeffer F.A.

1948 *Stratigraphie comparee et chronologie de l'Asie Occidentale*. London.

Schmagliy N.M., Cherniakov I.T.

1985 Kurgany na levoberezhze Nizhnego Dnestra. *Novye materialy po arxeologii Severo-Zapadnogo Prichernomor'ya*, 95-132. Kiev.

Šebela L.

1999 *The Corded Ware Culture in Moravia and in the Adjacent Part of Silesia (Catalogue)*. Brno.

Segeda S.P.

2000 Naselenie katakombnoy kultury Severo-Zapadnogo Prichernomor'ya po dannym arkheologii. In: *Chobruchskiy arkheologicheskiy kompleks i drevnie kultury Podnestrovia*, 103-107. Tiraspol.

Shaposhnikova O.G.

1978 Ingul'skaya kultura. In: *Arkheologicheskie issledovaniya na Ukraine v 1976 – 1977 gg. Tezisy*, 6-8. Uzhgorod.

Shaposhnikova O.G., Fomenko V.N., Dovzhenko N.D.

1986 *Yamnaya kulturno-istoricheskaya oblast (yuzhnobugskiy variant)*. Kyiv.

Sharafutdinova I.N.

1989 Khoziaystvo plemen sabatinovskoy kultury. In: *Pervobytnaya arkheologiya. Materialy i issledovaniya (sbornik nauchnykh trudov)*, 168-179. Kyiv.

Shepel K.A.

1985 *Naseleniye basseyna Severskogo Donsa v epokhu eneolita – bronzy po antropologicheskim dannym. Avtoreferat dissertatsii na soiskaniye uchonoy stepeni kandidata istoricheskikh nauk*. Kyiv.

Shishlina N.I.

2007 Severo-Zapadnyi Prikaspiy v epokhu bronzy (V–III tys. do n. e.). *Trudy Gosudarstvennogo Istoricheskogo Muzeya* 165. Moskva.

2013 Steppe und Kaukasus. Ein Dialog der Kulturen. In: *Bronzezeit. Europa ohne Grenzen 4. – 1. Jahrtausend v. Cr. Ausstellungskatalog*, 128-139. Sankt Petersburg.

Shmagliy N.M., Cherniakov I.T.

1970 Issledovaniya kurganov v stepnoy chasti mezhdurechia Dunaya i Dnestra. *Materialy po arkheologii Severnogo Prichernomor'ya* 6: 5-90.



Shramko B.A., Mashkarov Yu.G.

- 1993 Issledovanie bimetallicheskogo nozha iz pogrebeniya katakombnoy kul'tury. *Sovetskaya arkheologiya* 2: 163-170. Moskva.

Simion G.

1991. O noua cultura de la inseputul epozii bronzului pe teritoriul Istro-Pontic, Peuce X (I): 33–34.

Sinika V.S., Razumov S.N., Telnov N.P.

- 2013 *Kurgany u sela Butory. Arheologicheskie pamyatniki Pridnestrovyia: 1.* Tiraspol.

Siniuk A.T., Matveev Yu.P.

- 2007 *Srednedonskaya katakombnaya kultura epokhi bronzы (po dannym kurgannykh kompleksov).* Voronezh.

Smirnova G.I.

- 1976 Magala I i nekotorye voprosy khronologii pozdnekomarovskoy kul'tury v Prikarpatе. In: S.S.Berezanskaya et al. (Eds) *Eneolit i bronzovyi vek Ukrainy. Issledovannya i materialy*, 119-135, Kyiv.

Spindler K.

- 1993 Die Mumie. In: M. Egg, R. Goedecker-Ciolek, W. Groenman-Van Waateringe, K. Spindler (Eds) *Die Gletschermumie vom der Steizeit aus dem Öztaler Alpen*, 27-35. Mainz.

Stefanović S.

- 2006 Animal canines as possible symbol of rank in early Bronze Age Mokrin. *Strukturno-semioticheskie issledovaniya v arkheologii* 3: 201-214.

Stloukal M.

- 1985 Antropologický rozbor koster z pohřebišť v Holešově. *Studie Muzea Kroměřížska* '85: 131-169.

Subbotin L.V.

- 1982 Dva kurgana epokhi bronzы v Bugo-Dnestrovskom mezhdurechie. In: A.V. Gudkova (Ed.) *Arkheologicheskie pamiatniki Severo-Zapadnogo Prichernomoria*: 100-110. Kyiv.

- 1985 Semenovskiy mogilnik epokhi eneolita-bronzы. In: V.N. Stanko (Ed.) *Novye materialy po arkheologii Severo-Zapadnogo Prichernomoria*: 45-95. Kyiv.

- 2000 Severo-Zapadnoe Prichernomorie v epokhu ranney i sredney bronzы. *Stratum plus* 2: 350-387.

- 2003 *Orudiya truda, oruzhie i ukrasheniya yamnoj kul'tury Severo-Zapadnogo Prichernomorya.* Odessa.

- Subbotin L.V., Dobroliubskiy A.O., Toshev G.N.  
 1995 Pamiatniki epokhi bronzy kurgannogo mogilnika Gradeshka. *Drevnosti Stepnogo Prichernomoria i Kryma* 5: 109-126.
- Subbotin L.V., Ostroverkhov A.S., Dzigovskiy A.N.  
 1995 *Arkheologicheskie drevnosti Budzhaka. Kurgany u s. Trapovka i Novoselitsa*. Odessa.
- Subbotin L.V., Dzigovskij A.N., Majorov V.N.  
 1984 *Ohrannye raskopki u s. Ogorodnoe*. Severnoe Prichernomorje. Kiev: 104-112.
- Sulimirski T.  
 1968 *Corded Ware and Globular Amphorae North-East of the Carpathians*. London.
- Sveshnikov I.K. = Swieszchnikow I.  
 1967 Kultura komarowska. *Archeologia Polski* 12(1): 39-107.  
 1968 Bogatye pogrebeniya komarovskoy kultury u s. Ivania Rovenskoj oblasti. *Sovetskaya arkheolohiya* 2: 159-168.  
 1974 *Istoriya naselennia Peredkarpattia, Podillia i Volyni v kintsi III – na pochatku II tysiacholittya do nashoyi ery*. Kyiv.  
 1976 Problema proiskhozdheniya komarovskoy kultury. In: S.S.Berezanskaya et al. (Eds) *Eneolit i bronzovyi vek Ukrainy. Issledovannya i materialy*, 96-118. Kyiv.  
 1990 Stzhizhovskaya kultura. In: E.A. Balaguri, O.P. Chernykh (Ed.) *Arkheologiya Prikarpatia, Volyni i Zakarpatia. Eneolit, bronza i rannee zhelezo*, 68-74. Kyiv.  
 1993 Novi pokhovannia pochatku bronzovoho viku na Zakhidniy Volyni. *Studia archaeologica* 1: 23-31.
- Syniuk A.T.  
 1996 *Bronzovyi vek basseyna Dona*. Voronezh.
- Szabó Gábor V.  
 1997 A Perjámos-Kultúra leletei hódmezővásárhely környékén. In: *Látták Trója kapuit. Bronzkori leletek a Közep-Tisza vidékéről*: 57-84. Gyula.
- Szathmári I.  
 1983 Kisapostager Gräber im bronzezeitlichen Gräberfeld von Dunaújváros. *Alba Regia* 20: 7-36.  
 1996 Bronze wire and sheet ornaments of the Vatya culture. In: T. Kovács (Ed.) *Studien zur Metallindustrie im Karpatenbecken und den benachbarten Regionen*, 75-87. Budapest.

2002 Neue angaben über die Funde der Vatyá-Kultur in der Umgebung von Szigetszentmiklós. *Budapest Régiségei* XXXVI: 235-246.

Szmyt M.

1999 Between West and East. People of the Globular Amphora Culture in Eastern Europe 2960–2350 BC. *Baltic-Pontic Studies* 8.

2000 In the Far of Two Worlds. On the Study of Contacts between the Societs of the Globular Amphora and Yamnaya Cultures. In: S. Kadrow (Ed.) *A Turning of Ages. Im Wander der Zeiten. Jubilee Book Dedicated to Professor Jan Machnik on His 70th Anniversary*, 443-466. Kraków.

Szmyt M., Cherniakov I.T.

1999 Radiocarbon Chronology of «Akkiembetski Kurgan». A Preliminary Report. In: A. Koško (Ed.) *The Foundations of Radiocarbon Chronology of Cultures Between the Vistula and Dnieper: 3150-1850 BC* *Baltic-Pontic Studies* 7: 196-202.

Šebela L.

1999 *The Cordered Ware Culture in Moravia and in the Adjacent Part of Silesia (Catalogue)*. Brno.

Ślusarska K.

2006 *Funeral rites of the Catacomb community: 2800-1900 BC ritual, thanatology and geographical origins*. *Baltic-Pontic Studies* 13.

Taras H.

2007 Oddziaływania wschodnioeuropejskie w starszych fazach epoki brązu na społeczności w dorzeczu górnej i środkowej Wisły (ze szczególnym uwzględnieniem Lubelszczyzny). In: M. Gierlach, L. Bakalarska (Eds) *Wspólnota dziedzictwa archeologicznego ziem Ukrainy i Polski. Materiały z konferencji zorganizowanej przez Ośrodek Ochrony Dziedzictwa Archeologicznego. Łańcut (26-28 X 2005 r., 179-195. Warszawa)*.

Tatarinov S.I.

1993 *Drevniy metall Vostochnoy Ukrainy. Ocherki rekonstruktsii gornogo dela, metallurgii i metalloobrabotki v epokhu bronzy (uchebnoe posobie)*. Artemovsk.

Telegin D.Ya.

1991 *Vartovi tysiacholit*. Kyiv.

Telegin D.Y., Pustovalov S.Z., Kovaliukh N.N.

2003 Relative and absolute chronology of Yamnaya and Katakomb monuments the issue of co-existence. A.Koško, V.I. Klochko (Ed.) *The Foundations of Radiocarbon Chronology of Cultures between the Vistula and Dnieper: 4000- 1000 BC*. *Baltic-Pontic Studies* 12: 132-184.

Terenozhkin A.I.

1961 *Predskifskiy period na Dneprovskom Pravoberezhje*. Kyiv.

Titenko G.T.

1955 Kamennaya stela iz s. *Pervomaevka*. *Kratkie soobshcheniya Instituta archeologii AN USSR*. 5 78-79.

Toshev G.

1987 *Sredniy period bronzovogo veka yugo-zapada SSSR*. (held in the archives of INION AN SSSR. 19.06. g., № 29903.)

1986 Zapadnye sviazi kultury mnogovalikovoi keramiki v Severo-Zapadnom Prichernomorie. In: V.N. Stanko, I.T. Cherniakov (Eds) *Issledovaniya po arkheologii Severo-Zapadnogo Prichernomoria*: 104-115. Kyiv.

1991 Zapadniy areal pamiatnikov katakombnoy kultury. In: *Katakombnye kultury Severnogo Prichernomoria*, 85-100. Kyiv.

1992 *Kurgany epoxi bronzы mezhdurechya Yalpuga i Kagula*. Zaporozhe.

1998 Cultura catacombelor și contactelele ei în partea de vest a arealului. *Thraco-Dacica* 19: 51-69.

2007 *Krym v epokhu bronzы*. Zaporozhe.

Truhelka C.

1909 Kupferfund von Karavida. *Wissenschaftliche Mitteilungen aus Bosnien und der Herzegovina* 11: 50-54.

Vajsov I.

1993 Die frühesten Metalldolche Südost- und Mitteleuropas. *Prähistorische Zeitschrift* 68: 103-145.

Vandkilde H.

1999 Social Distinction and Ethnic Reconstruction in the Earliest Danish Bronze Age. In: *Eliten in der Bronzezeit. Ergebnisse Zweier Kolloquien in Mainz und Athen, vol.1*, 245-276, Mainz.

Vasiliev I.B.

1999 Poselenie Lbische na Samarskoy Luke i nekotorye problemy bronzovogo veka Srednego Povolzhia. In: *Voprosy arkheologii Urala i Povolzhia. K 30-letiyu Srednevolzhskoy arkheologicheskoy ekspeditsii*, 66-114. Samara.

2003 Volsk-Lbische – novaya kulturnaya gruppa epokhi sredney bronzы v Volgo-Uralie. In: *Abashevskaya kulturno-istoricheskaya obshchnost: istoki, razvitie, nasledie*, 107-115. Cheboksary.

Vladár J.

1973 Osteuropäische und mediterrane Einflüsse im Gebiet der Slowakei während der Bronzezeit. *Slovenská Archaeologia* 21: 253-357.

Vollmann D.

- 2009 Der Makó-Kosihy-Čaka-Komplex und die früheste Nagyrév-Kultur an Donau und Theiß. In: V.Becker, M.Thomas, A.Wolf-Schuler *et al.* (Eds) *Zeiten – Kulturen – Systeme. Gedenkschrift für Jan Lichardus*, 271-288. Langenweißbach.

Vulpe A.

- 1961 K voprosu o periodizastii bronzovogo veka v Moldove. *Dacia* 5: 106-122.  
1970 Die Äxte und Beile in Rumänien I. In: *Prähistorische Bronzefunde* 9(2). München.

Vynokur J., Hucal A., Mehey V.

- 1998 Doslidzhennia kurhaniv doby bronzы u seli Dorohoschi na Volyni. *Zapysky Naukovoho Tovarystva imeni Shevchenka* 235, Pratsi Archeolohichnoyi komisii: 433-465.

Wallerstein E.

- 1974 *The Modern World-System: Capitalist Agriculture and the Origins of the European World-Economy in the Sixteenth Century*. New York.

Wason P.

- 1994 *The archaeology of rank*. Cambridge.

Wetzel G.

- 1990 Die Schnurkeramik in der Oberlausitz und Niederlausitz. *Praehistorica* 19: 43-56.

Witkowska B.

- 2006 Corded Ware culture settlements on Central Europe uplands. *Sprawozdania Archeologiczne* 58: 21-102.

Włodarczak P.

- 1998 Groby kultury mierzanowickiej oraz kultury trzcinieckiej z Żernik Górnych. In: A. Koško, J. Czebreszuk (Eds) „Trzciniec” – system kulturowy czy interkulturowy proces?, *Archeologia Bimaris. Dyskusje* 1, 161-177. Poznań.  
2006 *Kultura ceramiki sznurowej na Wyżynie Małopolskiej*. Kraków.  
2008 *Kultura żłocka i problem genezy kultury ceramiki sznurowej w Małopolsce. Na pograniczu światów. Studia z pradziejów międzymorza bałtycko-pontyjskiego ofiarowane Profesorowi Aleksandrowi Koško w 60 rocznicę urodzin*. Poznań: 555-576.  
2010 Dunajski szlak kultury grobów jamowych a problem genezy kultury ceramiki sznurowej. In: S. Czopek, S. Kadrow (Eds) *Mente et rutro. Studia archeologica Johanni Machnik viro doctissimo octogesimo vitae anno ab amicis, collegis et discipulis oblata*, 299-325. Rzeszów.

Yarovoy E.V.

- 1983 Ohrannyye raskopki u s. Ketrosy. *Pervobytnyye drevnosti Moldavii*. Kishinev: 110-128.
- 1985 *Drevneyshie skotovodcheskie plemena yugo-zapada SSSR (klassifikatsiya pogrebalnogo obriada)*. Kishinev.
- 1990 *Kurgany epokhi eneolita-bronzy Nizhnego Podnestrovia*. Kishinev
- 2000 *Skotovodcheskoe naselenie Severo-Zapadnogo Prichernomoria epokhi rannego metalla*. Avtoreferat dissertatsii na soiskanie nauchnoy stepeni doktora istoricheskikh nauk. Moskva.

Yefimenko P.P, Tretiakov P.N.

- 1961 Abashevskaya kultura v Povolzhie. *Materialy i issledovaniya po arkheologii SSSR* 97: 43-110.

Yovanovich B.

- 1994 Eneoliticheskoe srebro Balkan i Severo-Pontiyskogo Regiona. In: E.V. Yarovoy (Ed.) *Drevneyshie obschnosti zemledeltsev i skotovodov V tys. do n. e. – V v. n. e.: materialy mezhdunarodnoi arkheologicheskoi konferentsii; Tiraspol 10–14 oktiabريا 1994 g.*, 41–42. Tiraspol.

Zahoruiko V.T., Lotorska T.V., Potupchik M.V., Potupchik M.E.

- 1993 Pokhovannia yamnoyi kultury bilia s. Pysarivka. In: *Podilska starovyna*, 108-125. Vinnitsa.

Ziábka L.

- 1987 Cmentarzysko z II okresu epoki brązu z Borku, gm. Godzieszcze Wielkie (stanowisko 1). In: *Kultura trzcinienska w Polsce*, 89-105. Kraków.

Zolashko G.M. (=Zalashka G.M.)

- 1982 *Otchet ob arkheologicheskikh issledovaniakh v Gomelskoy i Brestskoy oblastsiakh v 1982 godu* (held in the archives of II NANB, nr. 806).
- 1983a Kimbarauskae garadzischa. *Pomniki gistoryi i kultury Belarusi* 4: 37-38.
- 1983b *Otchet o polevykh issledovaniakh na territorii pravoberezhya Pripiatsi v 1983 godu* (held in the archives of II NANB, nr. 881).



## LIST OF AUTHORS

Jacek Górski  
Archeological Museum of Kraków  
Senacka 3  
31-002 Kraków  
Poland  
E-mail: jgorski@ma.krakow.pl

Svitlana Ivanowa  
Institute of Archaeology  
National Academy of Science of Ukraine  
Heroyiv Stalingrada 12  
04210 Kyiv  
Ukraine  
E-mail: svi1956@gmail.com

Liubov S. Klochko  
Museum of Historical Treasures of Ukraine  
Sichnevogo povstannia 21  
011015 Kyiv  
Ukraine  
E-mail: vklochko@ukr.net

Viktor I. Klochko (Kloczko)  
Department of Archaeology  
National University of Kyiv-Mohyla Akademy  
Skovorody 2  
04665 Kyiv  
Ukraine  
E-mail: vklochko@ukr.net

Aleksander Koško  
Institute of Prehistory  
Adam Mickiewicz Univeristy  
Św. Marcin 78  
61-809 Poznań  
Poland  
E-mail: antokol@amu.edu.pl

Mikola Kryvaltsevich  
Institute of History  
Academy of Sciences of Belarus  
F. Skoryna 1  
220072 Minsk  
Belarus  
E-mail: kryvalsevich.arch@tut.by

Sergey D. Lysenko  
Institute of Archaeology  
National Academy of Science of Ukraine  
Heroyiv Stalingrada 12  
04210 Kyiv  
Ukraine  
E-mail: suraganga@andex.ru

Roman O. Lytvynenko  
Donetsk National University  
Arktiki 6.1-47  
83056 Donetsk  
Ukraine  
E-mail: litrom@andex.ua

Przemysław Makarowicz  
Institute of Prehistory  
Adam Mickiewicz University  
Św. Marcin 78  
61-809 Poznań  
Poland  
E-mail: przemom@amu.edu.pl

Vitaliy V. Otroshchenko  
Institute of Archaeology  
National Academy of Science of Ukraine  
Heroyiv Stalingrada 12  
04210 Kyiv  
Ukraine  
E-mail: otrok\_o@ukr.net

Gennadij N. Toshev  
Zaporizhyya National University  
Zhukovskogo Street 66  
69063 Zaporizhzhyya  
Ukraine  
E-mail: gent51@mail.ru

- Vol.1: *Weapons of the Tribes of the Northern Pontic Zone in the 16th–10th Centuries BC.*, by Viktor I. Klochko.
- Vol.2: *Nomadism and Pastoralism in the Circle of Baltic–Pontic Early Agrarian Cultures: 5000–1650 BC*, edited by Aleksander Koško.
- Vol.3: *Cemeteries of the Sofievka type: 2950–2750 BC*, edited by Aleksander Koško.
- Vol.4: *Eastern Exodus of the Globular Amphora People: 2950–2350 BC*, edited by Aleksander Koško.
- Vol.5: *Beyond Balkanization*, edited by Lucyna Domańska, Ken Jacobs.
- Vol.6: *The Trzciniec Area of the Early Bronze Age Civilization: 1950–1200 BC*, edited by Aleksander Koško.
- Vol.7: *The Foundations of Radiocarbon Chronology of Cultures Between the Vistula and Dnieper: 3150–1850 BC*, edited by Aleksander Koško.
- Vol.8: *Between West And East People of The Globular Amphora Culture in Eastern Europe: 2950-2350 BC*, by Marzena Szmyt.
- Vol.9: *The Western Border Area of the Tripolye Culture*, edited by Aleksander Koško.
- Vol.10: *Weaponry of Societes of the Northern Pontic Culture Circle: 5000–700 BC*, by Viktor I. Klochko.
- Vol.11: *Fluted Maces in the System of Long-Distance Exchange Trails of the Bronze Age: 2350–800 BC*, edited by Aleksander Koško.
- Vol.12: *The Foundations of Radiocarbon Chronology of Cultures Between the Vistula and Dnieper: 4000–1000 BC*, edited by Aleksander Koško and Viktor I. Klochko.
- Vol.13: *Funeral Rites of the Catacomb Community: 2800–1900 BC Ritual, Thanatology and Geographical Origins*, by Katarzyna Ślusarska.
- Vol.14: *Routes between the Seas: Baltic-Bug-Boh-Pont from the 3rd to the Middle of the 1st Millennium BC*, edited by Aleksander Koško and Viktor I. Klochko.
- Vol.15: *‘Cord’ Ornaments on Pottery in the Vistula and Dnieper Interfluvial Region: 5th – 4th Mill. BC*, edited by Aleksander Koško and Marzena Szmyt.
- Vol.16: *Flint Atrifacts of Northern Pontic Population of the Early and Middle Bronze Age: 3200 – 1600 BC*, by Serhiy M. Razumov
- Vol.17: *Wood Tar in the Dnieper and Elbe Communities: VI – II Millenium BC*, by Sławomir Pietrzak

Orders regarding *Baltic-Pontic Studies* should be addressed directly to the Editorial Office (*B-PS*, Institute of Prehistory, Św. Marcin 78, 61-809 Poznań, Poland). E-mail: [iplib@amu.edu.pl](mailto:iplib@amu.edu.pl); [antokol@amu.edu.pl](mailto:antokol@amu.edu.pl)  
Moreover, we are pleased to inform that *B-PS* volumes currently out of print (1, 2, 3, 4 and 8) are available online at the Adam Mickiewicz University Repository (AMUR): [repozytorium.amu.edu.pl](http://repozytorium.amu.edu.pl)

This publication is part of the National Science Centre research project, grant no. 2011/01/M/HS3/02142, in the context of publishing and related funding from Adam Mickiewicz University, Poznań.

ISBN 83-86094-18-4

ISSN 1231-0344